



Installation Instructions: 2007-13 Toyota Tundra Front Bumper

NOTES:

Some of the hardware is Stainless Steel and will bind to the nut if you do not put some kind of lubricant on the threads (wax, never cease, etc.)



Hardware:

- 400511 - Winch, Fair Lead Cover
 - 70008- 1/4-20 Nylock Nuts SS 2
 - 70039- 1/4 x 7/8 Fender Washer SS 4
 - 70060- 1/4-20 x 1" Button Head Bolt SS 2
- 400503.4 - Keys, Tool Box Lock Set

1. Remove the Left and Right ends Pannels underneath the head lights first

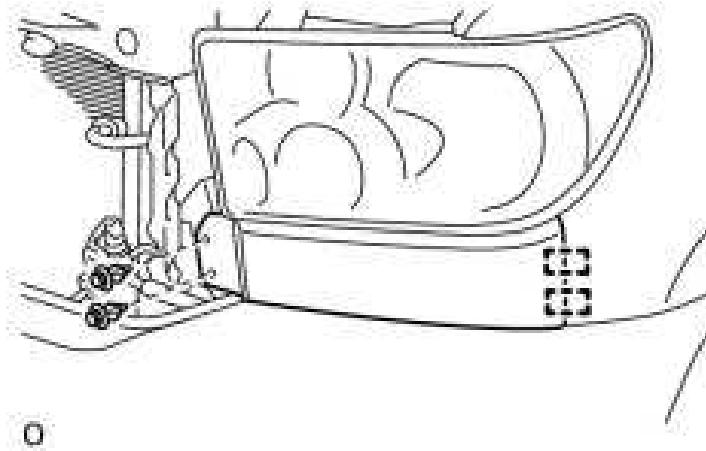

2. Remove Front Bumper Cover underneath each wheel well.



- a. Using a screwdriver (or clip remover) remove the 2 pin hold clips(top and bottom) and the 2 plastic clips (middle)

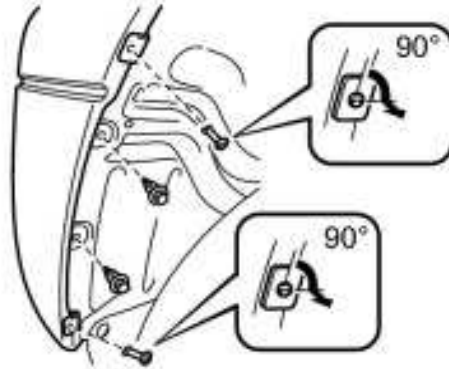

3. At this time it is suggested to put protective tape around the bumper cover to avoid possible scratches to your vehicle while removing the stock bumper and installing the Aluminess Bumper.
4. As seen in Figure 3, Remove the 8 clips and 9 screws that hold the plastic bumper on.

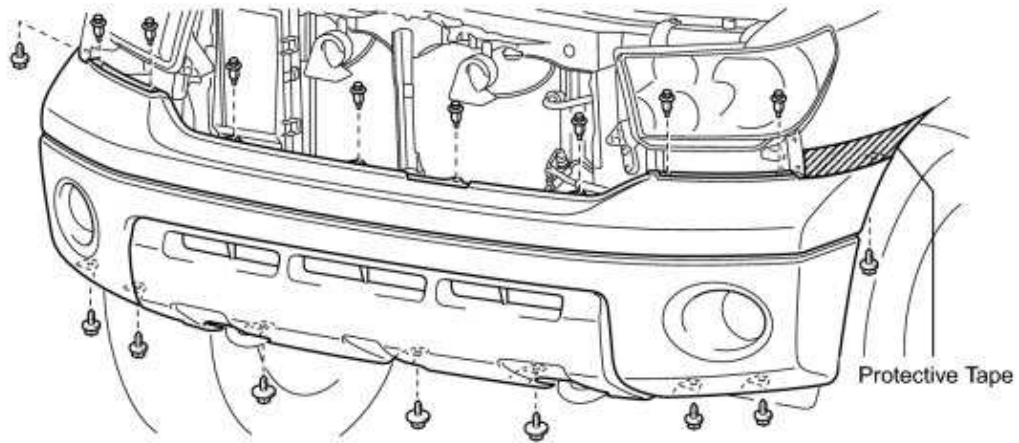

5. If your vehicle has Fog Lights, Disconnect the wire attachments and Detach the 4 claws to remove the bumper cover.

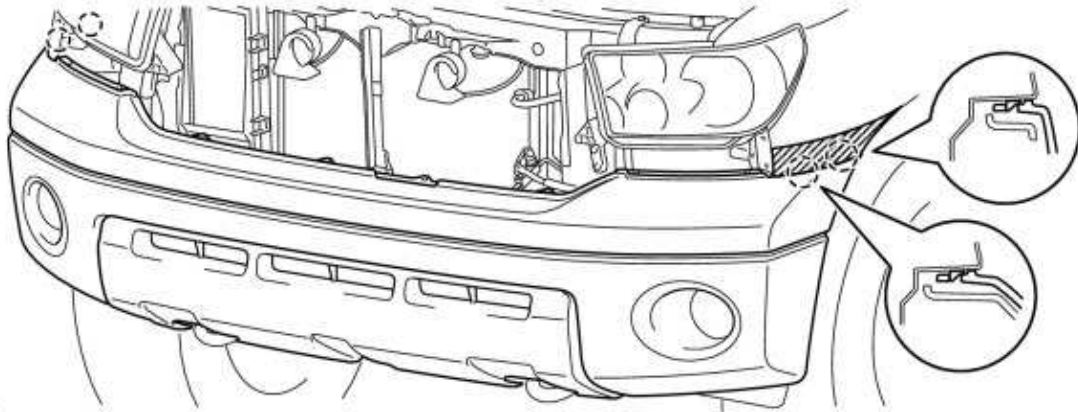

0

6. Remove the left and right Front Bumper Side support.
 - a. Remove the 2 screws
 - b. Detach the 3 clips and remove the side support.

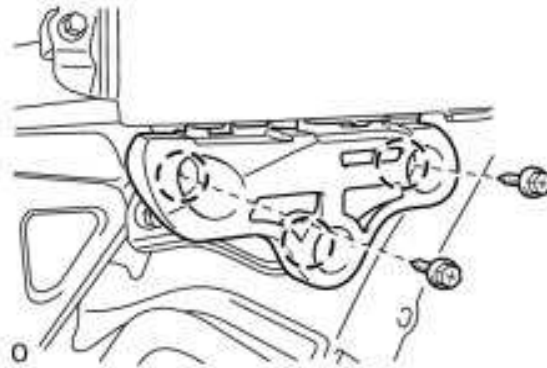

0

7. Remove Front Upper Center Bumper Retainer
 - a. Remove the 6 Nuts and Retainer

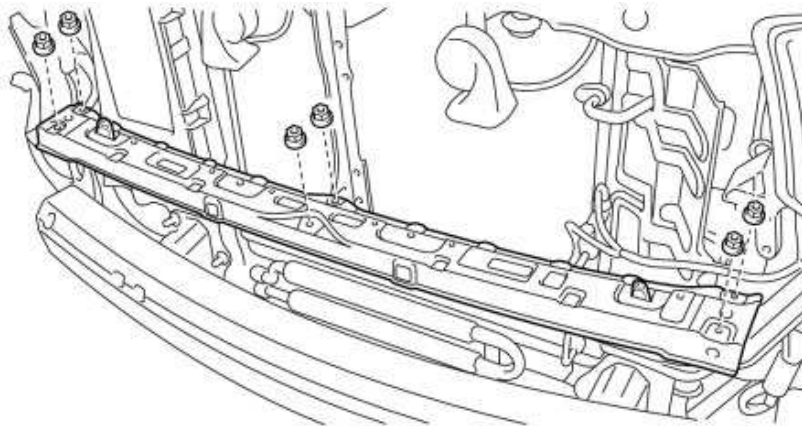

0



8. Remove the Left and Right bumper end retainer
 - a. Remove the 3 nuts and retainer (see fig 7)

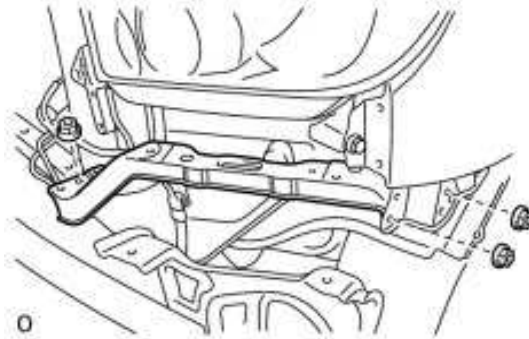

9. Remove Front Bumper Reinforcement
 - a. Remove the 6 nuts and reinforcement (see Fig 8)

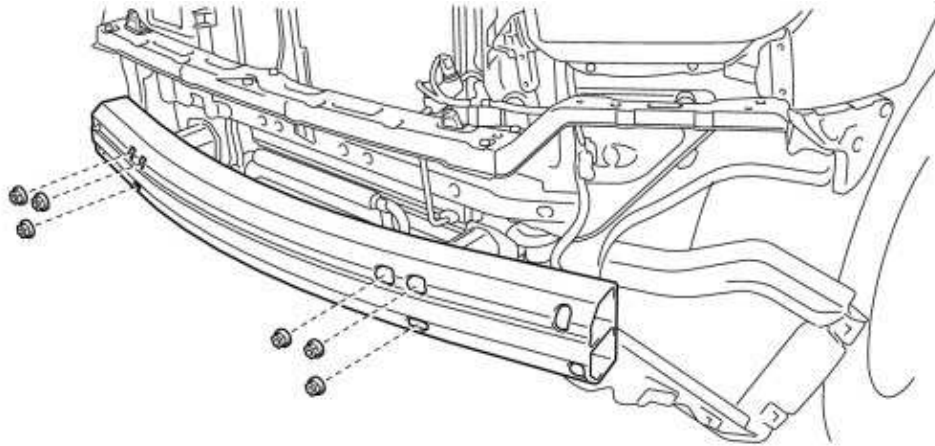

10. Remove Left and Right Front Bumper Extension Pieces
 - a. Remove the 4 nuts and bumper extension piece (see figure 9)
 - b. NOTE: Keep this hardware as it will be used to remount the Aluminess Bumper!

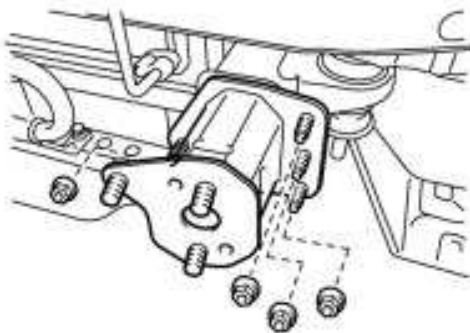



11. Install the Aluminess Bumper

- a. Place the Aluminess bumper over the 4 studs and using the nuts you have saved from the previous step, thread the nuts down until they are snug but do not tighten.
- b. Step back and make sure the bumper is centered.
- c. Tighten down the 4 nuts on each side.

