



INSTALLATION INSTRUCTIONS

SPORTSMAN & SPORTSMAN X GRILLE GUARD

APPLICATION:

2014-2019 Jeep Grand Cherokee

PART NUMBER:

40-3815, 45-3810, 40-33815

1	1	SPORTSMAN GRILLE GUARD ASSEMBLY	RATCHET
2,3	2	LOWER MOUNTING BRACKETS—DRIVER & PASSENGER	10MM SOCKET
4,5	2	UPPER SUPPORT STRAPS—DRIVER & PASSENGER	12MM SOCKET
5	4	M12 BUTTON HEAD BOLT (STAINLESS)	16MM SOCKET
6	4	M12 FLANGE NUT (STAINLESS)	18MM SOCKET
7	4	M12 CUPPED WASHER (STAINLESS)	ALLEN WRENCH
8	2	M8 BUTTON HEAD BOLT (STAINLESS)	TORQUE WRENCH
9	2	M8 HEX NUT (STAINLESS)	FLAT HEAD SCREW-DRIVER
10	2	M8 CUPPED WASHER (STAINLESS)	
11	2	M8 LOCK WASHER (STAINLESS)	
12	2	M8 FLAT WASHER (STAINLESS)	
13	4	M10 HEX BOLT	
14	4	M10 LOCK WASHER	
15	4	M10 FLAT WASHER	
16	2	M8 FLAT WASHER	

ANTI-SEIZE LUBRICANT MUST BE USED ON ALL STAINLESS STEEL FASTENERS TO PREVENT THREAD DAMAGE AND GALLING

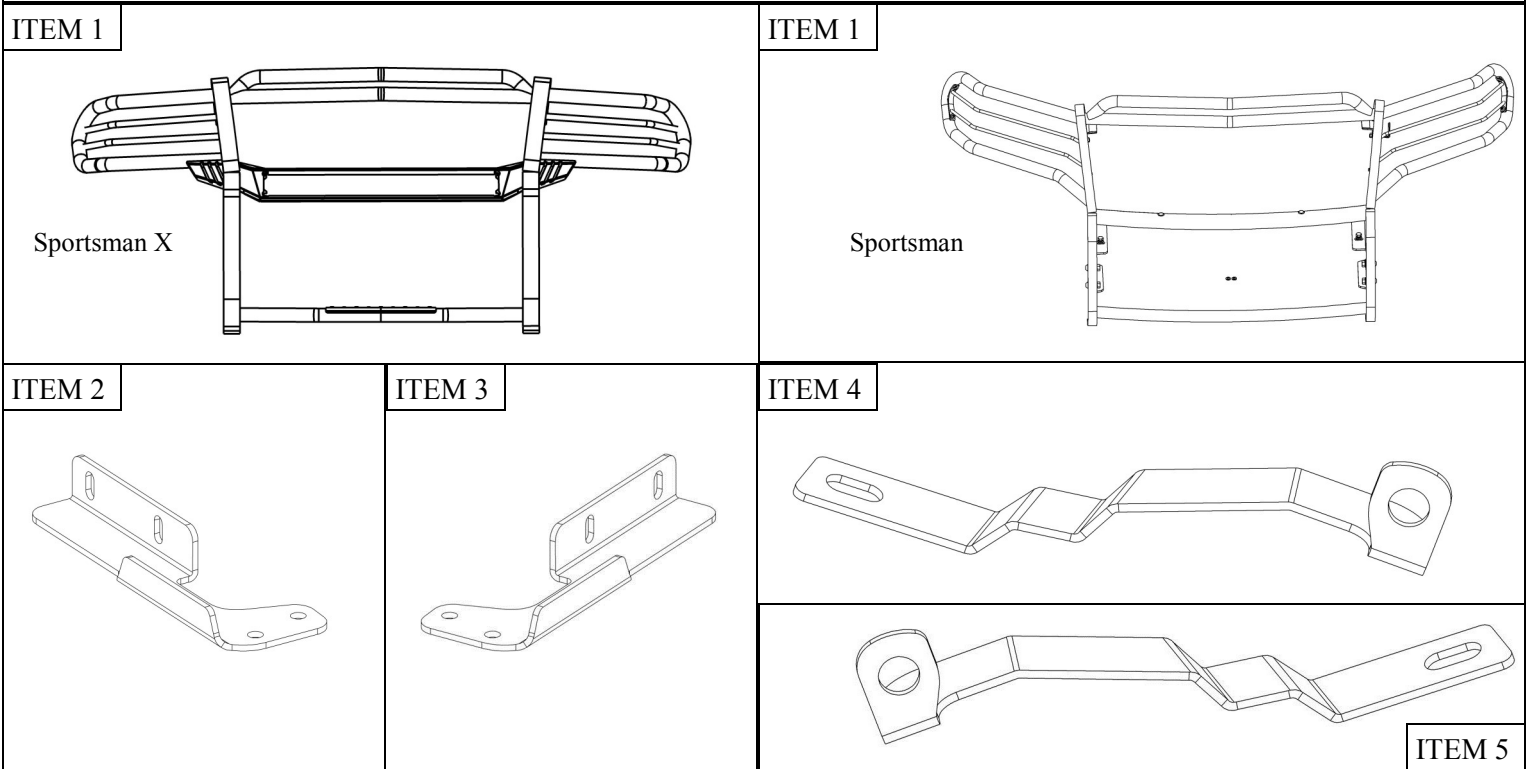

PROCEDURE

1. Remove contents from box, verify if all parts listed are present and free from damage.
Carefully read and understand all instructions before attempting installation.
Failure to identify damage before installation could lead to a rejection of any claim.

2. From beneath the vehicle gain access to the rear of the tow hook pockets by removing the plastic twist knobs and M6 bolts as shown in Figure 1.

Remove the plastic twist knob and M6 bolt to access the rear of the tow hook pockets (Driver side shown).

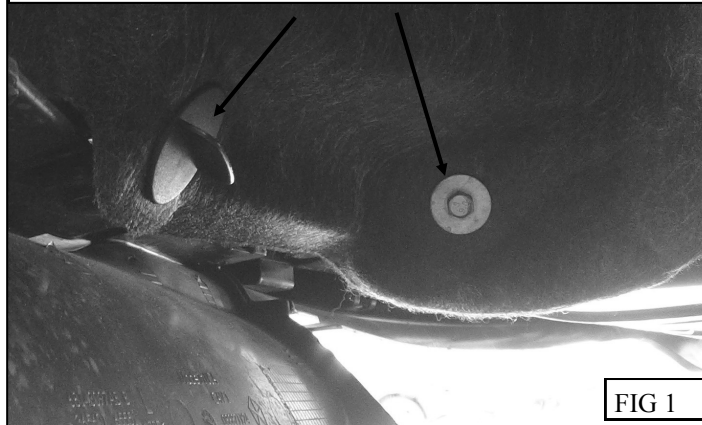

3. **Vehicles with factory tow hooks:** Remove the tow hooks by unscrewing the small bolts from the front of the hook and the large nut from the rear of the hook. Once the hook has been pulled through the front of the tow hook pocket the tow hook mounting bracket may be taken off by removing the two M10 bolts holding it in place. Refer to Figures 2 & 3.
Note: The factory tow hooks cannot be re-used.

Remove the large nut from the rear of the tow hook (Driver side shown).



Remove the small bolts from the front of the tow hook (Driver side shown).

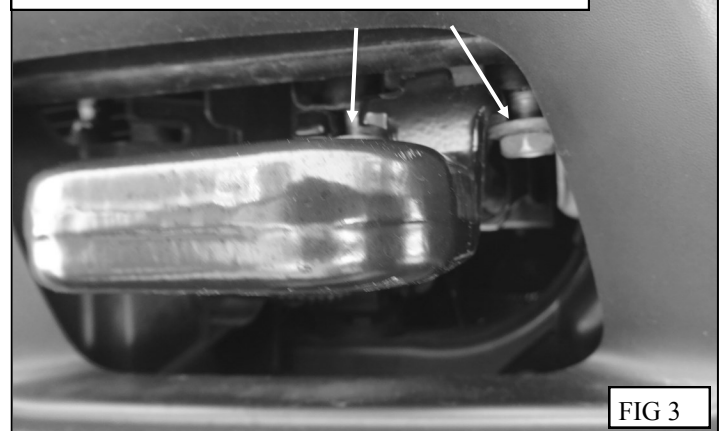

4. **Vehicles without factory tow hooks:** Remove the plastic tow hook pocket covers by carefully prying on them with a flat head screwdriver as shown in Figure 4.

Carefully pry off the tow hook pocket covers with a flathead screwdriver.

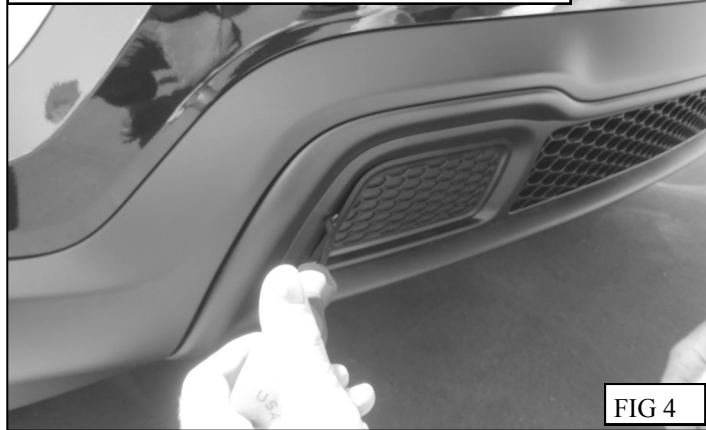

5. Place the Lower Mounting Brackets into the tow hook pockets. Loosely attach the brackets to the threaded holes in the vehicle's undercarriage using the supplied M10 Yellow Zinc hardware. Refer to **Figure 5**. *Note: It is recommended to install the front fasteners through the front of the tow hook pocket and the rear fasteners from the rear of the tow hook pocket.*
6. Open the hood of the vehicle. Remove the appropriate M6 fasteners from the radiator support. Use the M8 flat washer as a shim and slip the Upper Support Straps beneath the plastic cover. Loosely attach the straps using the factory M6 hardware. Refer to **Figure 6**.

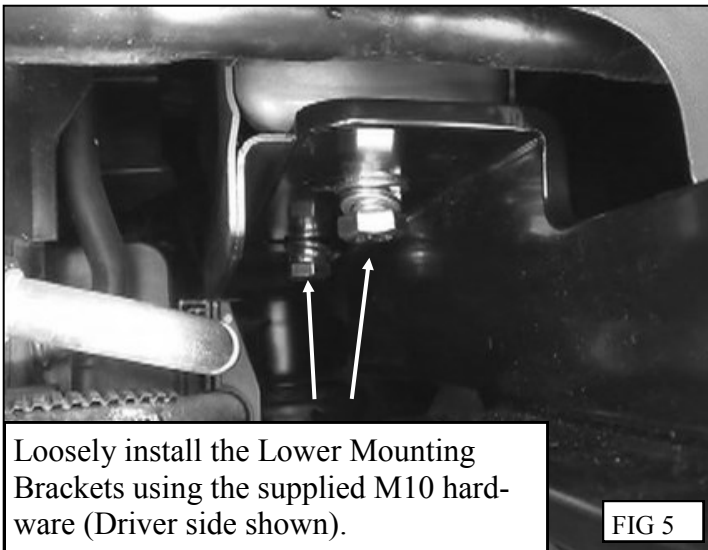

Loosely install the Lower Mounting Brackets using the supplied M10 hardware (Driver side shown).

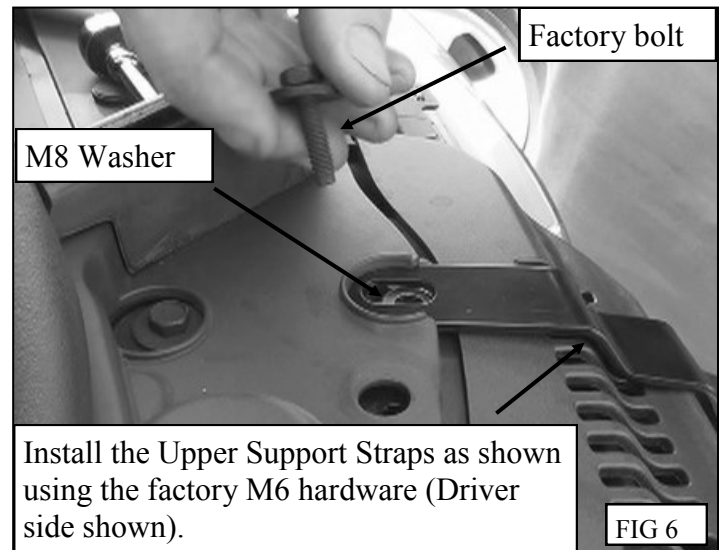

Install the Upper Support Straps as shown using the factory M6 hardware (Driver side shown).

7. With assistance loosely attach the Grille Guard to the Lower Mounting Brackets using the supplied M12 hardware. Loosely attach the Grille Guard to the Upper Support Straps using the supplied M8 hardware. Refer to Figure 7.
8. Align and adjust the Grille Guard as necessary then tighten and torque all hardware as follows: M8 to 15-18 ft-lbs.; M10 to 30-35 ft-lbs. M12 to 50-55 ft-lbs.

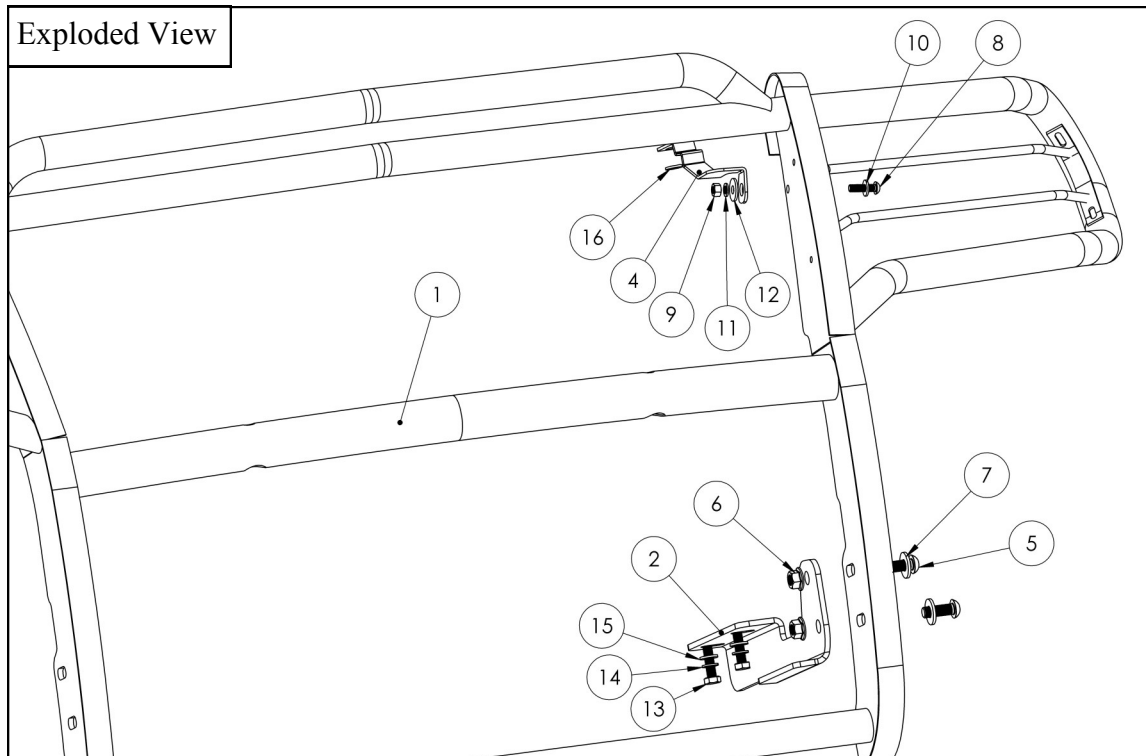
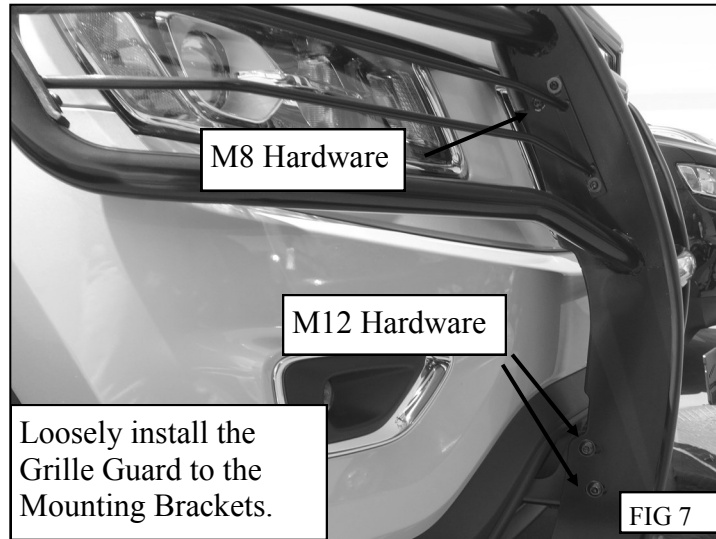

INSTALLATION COMPLETE



CARE INSTRUCTIONS

- REGULAR WAXING IS RECOMMENDED. DO NOT USE ANY TYPE OF POLISH OR WAX THAT MAY CONTAIN ABRASIVES.
- STAINLESS STEEL PRODUCTS CAN BE CLEANED WITH MILD SOAP AND WATER. STAINLESS STEEL POLISH SHOULD BE USED TO POLISH SMALL SCRATCHES.
- GLOSS BLACK FINISHES SHOULD BE CLEANED WITH MILD SOAP AND WATER.

WESTIN Westin Automotive Products, Inc.
320 W. Covina Blvd
San Dimas, Ca. 91773

Thank you for choosing Westin products
for additional installation assistance please call
Customer Service (800) 793-7846
www.westinautomotive.com



WARNING



Failure to follow these instructions could lead to death, personal injury, and / or property damage.

Failure to follow these instructions could lead to death, personal injury, and / or property damage.

FASTENERS:

All Westin supplied fasteners must be utilized and installed in accordance with the installation instructions and apply torque to the specifications as defined. **DOUBLE CHECK ALL FASTENERS BEFORE INITIAL USE, AND PERIODICALLY IN THE FUTURE TO ENSURE PROPER FUNCTION AND SAFETY.**

DRILLING:

Most Westin products do not require drilling for installation. If drilling is defined as required, use caution when drilling a vehicle. **FAILURE TO REVIEW AN AREA TO BE DRILLED MAY RESULT IN PERSONAL INJURY AND/OR INJURY TO OTHERS AS WELL AS VEHICLE DAMAGE.**

EYE PROTECTION:

ALWAYS WEAR SAFETY GLASSES OR GOGGLES DURING THE INSTALLATION PROCESS TO AVOID PERSONAL INJURY.

MAXIMUM TOWING/CARRYING CAPACITY: (if applicable)

The Westin Receiver Hitches will have a visible tow rating label affixed directly on the product. User should never exceed the vehicle manufacturers maximum tow and weight rating regardless of the capacity of the hitch. **FAILURE TO FOLLOW THESE GUIDELINES WILL VOID THE WESTIN WARRANTY AND MAY RESULT IN PERSONAL INJURY AND/OR INJURY TO OTHERS AS WELL AS VEHICLE DAMAGE.**

FOR CALIFORNIA RESIDENTS ONLY-PROP 65 WARNING:

Some products may contain chemicals such as DEHP, which can cause cancer, birth defects or other reproductive harm. For more info go to www.p65warnings.ca.gov