



INSTALLATION MANUAL
BLACK STEEL REAR BUMPER
PRODUCT NUMBER: DR19-T4450/ U4450
APPLICATION: 2019 DODGE HD



IMPORTANT SAFETY GUIDE | Your safety and the safety of others is very important.

In order to help you make informed decisions about safety, we have provided the following warnings, safety precautions, installation instructions, and other important information to alert you to potential hazards that could hurt you or others.

Please do a job safety analysis before each task to identify potential hazards for your situation and remove/protect against them. Use own good judgment and take your time.

Check packaged materials immediately upon arrival to ensure that all listed parts are included and undamaged.

Read and understand all warnings, safety precautions, and instructions before installing this product.

SENSORS FIELD OF VIEW MAY BE ALTERED WITH USE OF THE REPLACEMENT BUMPER.

WARNINGS

- Failure to observe the following warnings and instructions provided in this manual could lead to severe injury and/or death.
- For professional installation only. Careless installation and/or operation can result in serious injury, death, and/or equipment damage. All liability for installation and use rests with the user or consumer.
- Fab Fours, Inc. only approves installing this product according to these written instructions with the hardware provided. Failure to install according to these instructions will invalidate the warranty. This includes, but is not limited to, using alternative installation methods, hardware, or materials.
- This product is for off road use only.

SAFETY PRECAUTIONS

- Always remove jewelry and wear eye protection.
- Always use extreme caution when jacking up a vehicle for work. Set emergency brake and use tire blocks. Locate and use the vehicle manufacturers designated lifting points. Use jack stands.
- Always use appropriate and adequate care in lifting components into place.
- Always ensure components will remain secure during installation and operation.
- Always wear safety glasses when installing this kit. A drilling operation will cause flying metal chips. Flying chips can cause serious eye injury.
- Always use extreme caution when drilling a vehicle. Always disconnect power before welding. Thoroughly inspect the area to be drilled (on both sides of material when possible) prior to drilling, and relocate any objects that may be damaged.
- Always use extreme caution when welding a vehicle. Thoroughly inspect the area to be welded (on both sides of material when possible) prior to welding, and relocate any objects that may be a fire hazard. When welding in a cab, make sure the interior surfaces are covered (e.g., welding blanket) and a fire extinguisher is at hand.
- Always use extreme caution when cutting and trimming during fitting.
- Always tighten all nuts and bolts securely per installation instructions.
- Always route electrical cables carefully. Avoid moving parts, components that become hot, and rough or sharp edges.
- Always insulate and protect all exposed wiring and electrical terminals.
- Perform regular inspections and maintenance on mounts and hardware.

TABLE OF CONTENTS

- 2 SAFETY / DISCLAIMER
- 3 TABLE OF CONTENTS
- 4 A MESSAGE FROM THE OWNER
- 5 GETTING STARTED
- 6 PROVIDED MATERIAL
- 7 DISASSEMBLY
- 11 INSTALLATION
- 17 CONTACT

A MESSAGE FROM THE OWNER



Fab Fours' was born out of a passion for customizing vehicles and a love of the outdoors. Our engineering team uses the latest 3D design software to turn new product ideas into reality. In our factory, designs come to life with the combination of cutting edge technology for metal cutting and forming and an American workforce that puts its' heart and pride into every product.

From design and manufacturing, to quality and delivery, Fab Fours' mission is to be the market leader for steel truck and jeep accessories. We make sure a quality product is delivered on time, more than expected, better than expected to our customers.

Enjoy your new Fab Fours product. Welcome to the family!

Ereg Higgs

FOUNDER, FAB FOURS

GETTING STARTED

Before you begin the installation process of your new Fab Fours product, we suggest laying out all materials and parts on a pad or protective surface.

Failure to fully account for all components before beginning installation may leave vehicle immobile until part is acquired. Refer to the next pages as an inventory check.

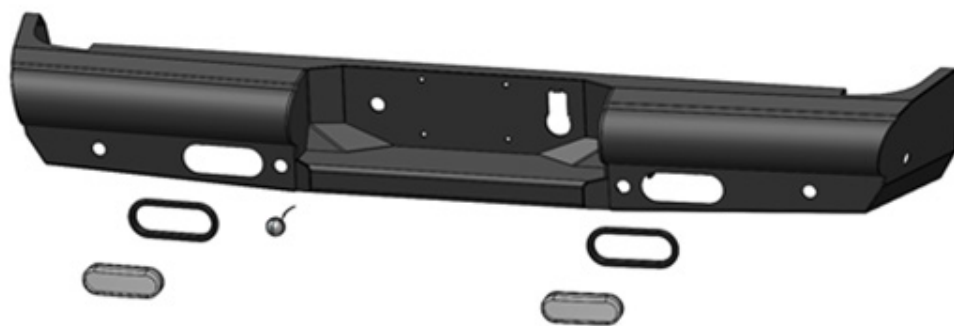

PROVIDED MATERIALS



EPOXY

61632
QTY: 2

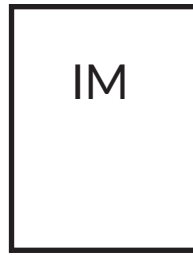

IM

T4450-IM



HW
KIT

50195-HW



21973



61363



61360 x2
(T4450 Only)



61361 x2
(T4450 Only)

HARDWARE KIT | 50195

FAB FOURS IDENTIFICATION	COMPONENT DESCRIPTION	QTY
50195-HW	1/4" Nylon License Plate Nut	4
50195-HW	1 3/8" Rubber Grommet	6
50195-HW	3/4" Plastic Plug	6
50195-HW	7/16"-14 x 1.25" Yellow zinc hex cap bolt, Grade 8	4
50195-HW	7/16"-14 Yellow zinc hex nut Grade 8	4
50195-HW	7/16" Yellow zinc flat washer Grade 8	8
50195-HW	7/16" Yellow zinc lock washer Grade 8	4
50195-HW	5/16" 1.5" OD Stainless steel fender washer	4
50195-HW	#8-32 x 3/4" Stainless steel button head cap screw	4
50195-HW	#8-32 Stainless Steel Nyloc Nut	4
50195-HW	#8 Stainless steel flat washer	4

TOOLS REQUIRED

- Plastic panel pry tool
- 5/8" Socket wrench
- Adjustable wrench
- 10mm socket wrench
- 15mm socket wrench
- 11/16" Socket Wrench
- 11/32" Socket wrench
- 3/32" Allen key
- Drill
- Zip-ties
- #16 drill bit
- T20 Star head socket wrench
- Dead blow hammer

ASSISTANCE

We recommend two people perform the installation as items are heavy and may need to be held in place while installing.

ORGANIZATION

Disassemble the vehicle where you can catalog and store everything. We suggest labeling and bagging all the OEM bolts when removing from the vehicle. Failure to keep track of parts could lead to an inability to properly reinstall components.

DISASSEMBLY

1. Using a 15mm socket wrench, remove the two (2) nuts from behind the license plate. (Figure 1)

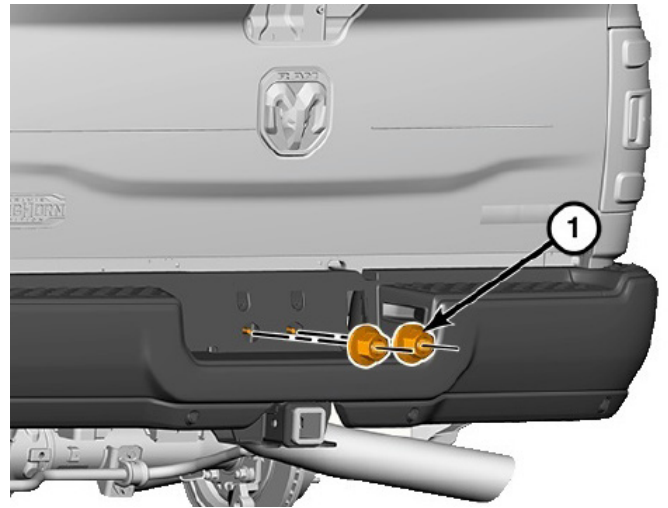

Figure 1

2. Disconnect the sensor and trailer plug harness by pulling back the red tab and separating the connectors. (Figure 2)



Figure 2

3. Using a 15mm socket wrench, remove the two (2) bolts connecting the bumper to the frame on both the driver and passenger side. (Figure 3)

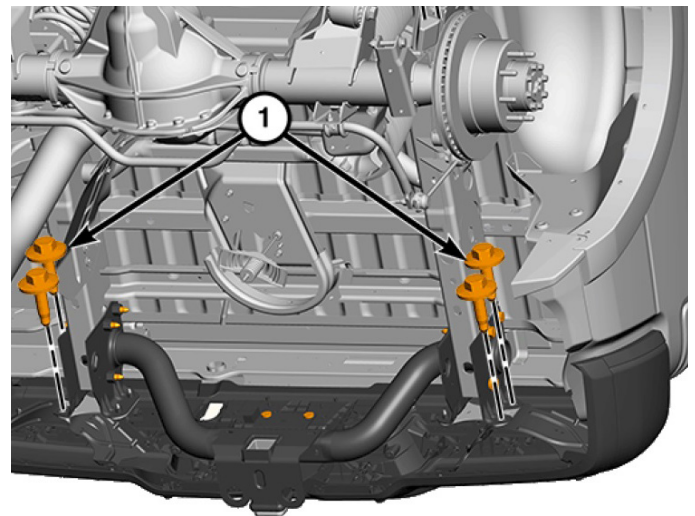

Figure 3

4. With assistance, remove the bumper from the truck. Using a 10mm socket wrench, remove the two (2) bolts and support plates from the frame rails on both the driver and passenger side. (Figure 4, #1)

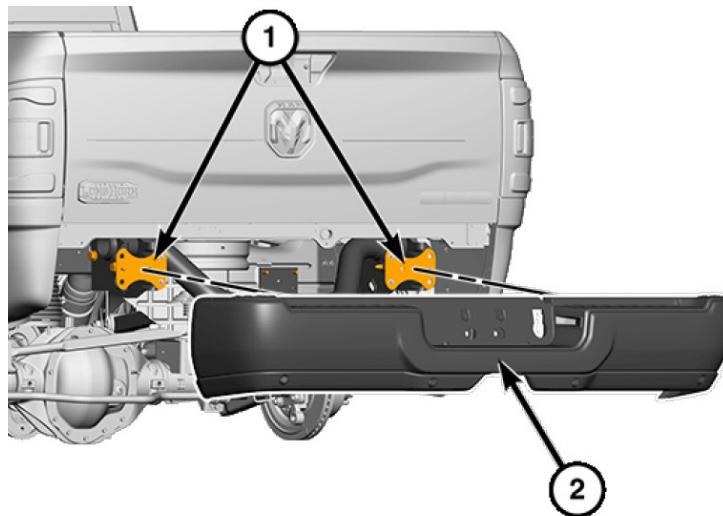

Figure 4

5. With the bumper off the truck, carefully unplug the wire harness from the trailer plug, license plate lights, keyless entry sensor and sensors. Using a plastic panel pry tool, remove the fasteners holding the harness to the OEM bumper. Remove the harness from the bumper and set aside for later use. (Figure 5-6)



Figure 5



Figure 6

6. Carefully remove the four (4) sensors from the OEM bumper by separating the fastening clips (Figure 7, #1) and lifting the sensor (Figure 7, #2) out of its housing.

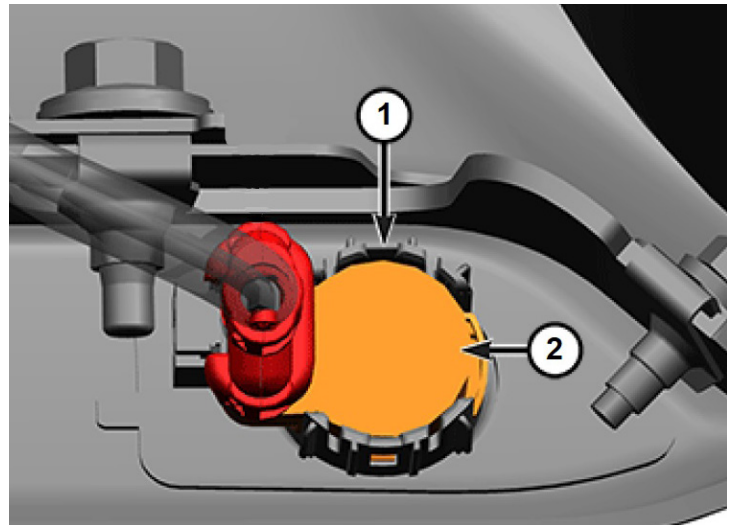

Figure 7

7. Using a 10mm socket wrench, remove the bolt holding the license plate lights in place and remove the lights from the OEM bumper. (Figure 8)



Figure 8

8. If equipped, using a T20 torx bit, remove the keyless entry sensor from the OEM bumper. (Figure 9)



Figure 9

9. Remove the trailer plug from the OEM bumper by depressing the two (2) metal clips on the sides and pushing the plug out of the bumper. (Figure 10)

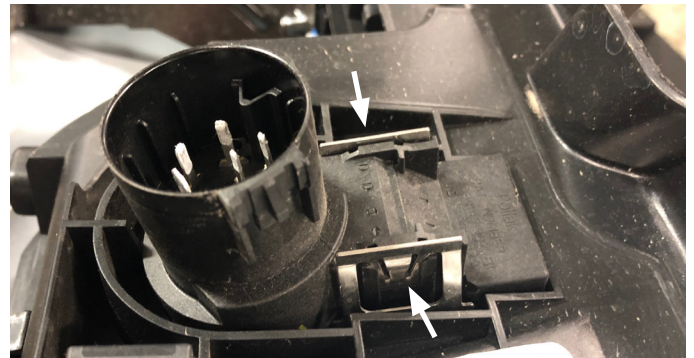

Figure 10

10. Figure 11 shows the components that will be used in your new Fab Fours bumper.

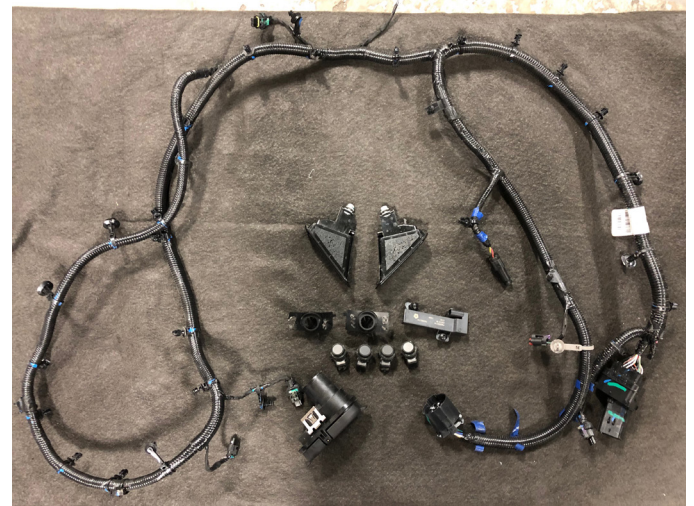

Figure 11

INSTALLATION

11. Using the supplied rubber grommets, insert them into the six (6) sensor openings in the shell of the bumper. (21973)(50195-HW)(Figure 12)



Figure 12

NOTE: If your vehicle doesn't have the side sensors, plug the two (2) unused sensor grommets in the wings with the included plastic plugs. Align the plastic plug, sensor grommet and soft end of hammer, slap the other end of hammer to seat the plastic grommet into the hole. (50195-HW)(Figure 13)



Figure 13

12. Install the four (4) or six (6) OEM sensors into the rubber grommets. (50189-HW) (Figure 14-15)

NOTE: Insertion of sensor into the rubber grommet is made easier by first wetting the rubber grommet with water, then while stretching the rubber grommet into an oval shape roll the sensor into position. Oil should not be used as a lubrication for the grommet as oil will not dry out. (Figure 14)

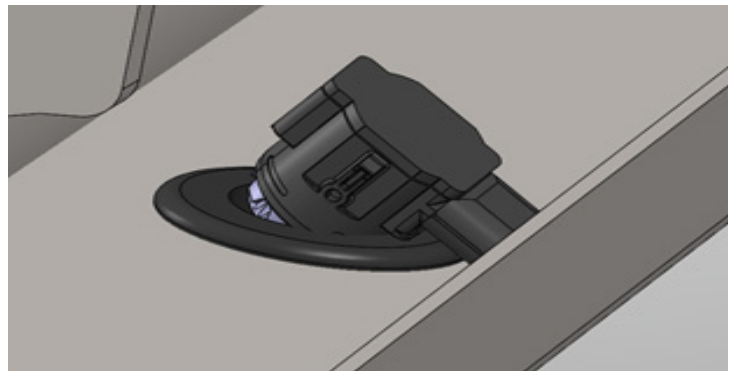

Figure 14

NOTE: The reverse lights (61360) and grommets (61361) install in the same manner as the OEM sensors do but are only provided with the tread plate version of this bumper. Install the reverse lights now if applicable.



Figure 15

13. Install the tag light into the 1 ¼" hole in the center section.



Figure 16

14. Using a drill and a #16 Drill Bit (.177"), drill The OEM Trailer Hitch Plug using in the locations pointed out with arrows below. Use care to drill directly in the center of the circles in the plastic. (Figure 16-17)

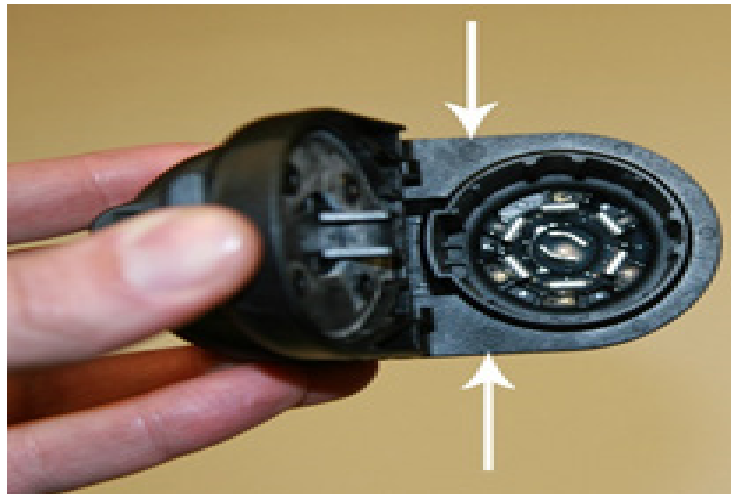

Figure 17

15. Using a 3/32" Allen key and 11/32" socket wrench, install the Trailer Plug into the Cutout in the new bumper using the #8-32 button head bolt, flat washer and #8-32 Nyloc nut. (50189-HW)

16. Using zip ties, begin securing the factory wiring harness as shown. (Figure 20-21)

NOTE: Figure 21 shows the wiring harness no-go zone in marked out. The factory hitch structure occupies this area.



Figure 20

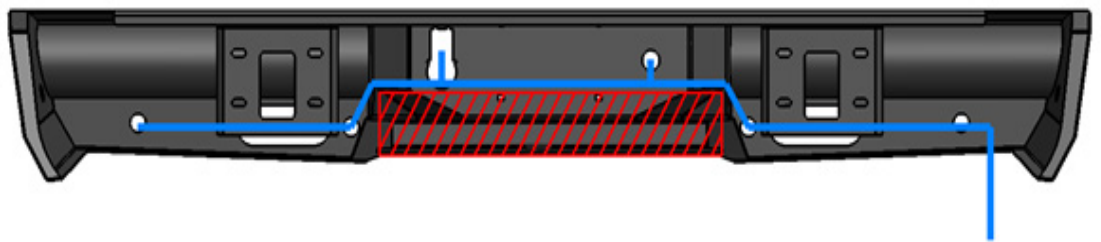

Figure 21

17. Connect the factory wiring harness to all the sensors and trailer plug.

18. Splice the Tag light provided to the factory wiring harness

NOTE: polarity doesn't matter when wiring up this led tag light. (Figure 22)



Figure 22

19. Using a dead blow hammer, bend the OEM bumper center mounting plate back towards the spare tire as the studs on that plate will interfere your new bumper. (Figure 23)



Figure 23

20. With assistance, lift and sit the bumper on the center hitch plate leaving a uniform gap all around the bumper to vehicle and loosely install the provided four (4) 7/16"-14 x 1.25" yellow zinc hex bolt, yellow zinc flat washers,

21. Loosely install the factory OEM bolt with the provided four (4) 5/16" clear zinc fender washers. (50195-HW)

22. Center the bumper with the vehicle and using a 10mm wrench, fully tighten down the four (4) factory OEM bolts with fender washers.

23. Using a 5/8" and 11/16" wrench, fully tighten down the four (4) 7/16" bolt stacks.

24. Reconnect the factory wiring harness to the vehicle and test all your lights and sensors.

25. Install the provided four (4) ¼" Nylon license plate Nuts with License plate. (50195-HW) (Figure 27)



26. Wire the reverse lights to your liking If applicable

CONTACT INFORMATION

**FAB FOURS INC.
2213 INDUSTRIAL PARK ROAD
LANCASTER, SC 29720**

PHONE: (803) 416-1100

FAX: 970-385-1914

EMAIL: SUPPORT@FABFOURS.COM

WWW.FABFOURS.COM



**“IF YOU’RE LOOKING FOR MORE OF THE SAME,
THEN YOU’VE COME TO THE WRONG PLACE.”**

- GREG HIGGS

