



**INSTALLATION MANUAL**  
**PREMIUM REAR BUMPER**  
**PRODUCT NUMBER: W4251**  
**APPLICATION: 2019 DODGE RAM 1500**



## **IMPORTANT SAFETY GUIDE** | Your safety and the safety of others is very important.

In order to help you make informed decisions about safety, we have provided the following warnings, safety precautions, installation instructions, and other important information to alert you to potential hazards that could hurt you or others.

Please do a job safety analysis before each task to identify potential hazards for your situation and remove/protect against them. Use own good judgment and take your time.

Check packaged materials immediately upon arrival to ensure that all listed parts are included and undamaged.

**Read and understand all warnings, safety precautions, and instructions before installing this product.**

SENSORS FIELD OF VIEW MAY BE ALTERED WITH USE OF THE REPLACEMENT BUMPER.

---

### **WARNINGS**

- Failure to observe the following warnings and instructions provided in this manual could lead to severe injury and/or death.
- For professional installation only. Careless installation and/or operation can result in serious injury, death, and/or equipment damage. All liability for installation and use rests with the user or consumer.
- Fab Fours, Inc. only approves installing this product according to these written instructions with the hardware provided. Failure to install according to these instructions will invalidate the warranty. This includes, but is not limited to, using alternative installation methods, hardware, or materials.
- This product is for off road use only.

---

### **SAFETY PRECAUTIONS**

- Always remove jewelry and wear eye protection.
- Always use extreme caution when jacking up a vehicle for work. Set emergency brake and use tire blocks. Locate and use the vehicle manufacturers designated lifting points. Use jack stands.
- Always use appropriate and adequate care in lifting components into place.
- Always ensure components will remain secure during installation and operation.
- Always wear safety glasses when installing this kit. A drilling operation will cause flying metal chips. Flying chips can cause serious eye injury.
- Always use extreme caution when drilling a vehicle. Always disconnect power before welding. Thoroughly inspect the area to be drilled (on both sides of material when possible) prior to drilling, and relocate any objects that may be damaged.
- Always use extreme caution when welding a vehicle. Thoroughly inspect the area to be welded (on both sides of material when possible) prior to welding, and relocate any objects that may be a fire hazard. When welding in a cab, make sure the interior surfaces are covered (e.g., welding blanket) and a fire extinguisher is at hand.
- Always use extreme caution when cutting and trimming during fitting.
- Always tighten all nuts and bolts securely per installation instructions.
- Always route electrical cables carefully. Avoid moving parts, components that become hot, and rough or sharp edges.
- Always insulate and protect all exposed wiring and electrical terminals.
- Perform regular inspections and maintenance on mounts and hardware.



# TABLE OF CONTENTS

- 2 SAFETY / DISCLAIMER
- 3 TABLE OF CONTENTS
- 4 A MESSAGE FROM THE OWNER
- 5 GETTING STARTED
- 6 PROVIDED MATERIAL
- 7 DISASSEMBLY
- 12 INSTALLATION

# A MESSAGE FROM THE OWNER

---



Fab Fours' was born out of a passion for customizing vehicles and a love of the outdoors. Our engineering team uses the latest 3D design software to turn new product ideas into reality. In our factory, designs come to life with the combination of cutting edge technology for metal cutting and forming and an American workforce that puts its' heart and pride into every product.

From design and manufacturing, to quality and delivery, Fab Fours' mission is to be the market leader for steel truck and jeep accessories. We make sure a quality product is delivered on time, more than expected, better than expected to our customers.

Enjoy your new Fab Fours product. Welcome to the family!

*Ereg Higgs*

**FOUNDER, FAB FOURS**

# GETTING STARTED

---

Before you begin the installation process of your new Fab Fours product, we suggest laying out all materials and parts on a pad or protective surface.

Failure to fully account for all components before beginning installation may leave vehicle immobile until part is acquired. Refer to the next pages as an inventory check.

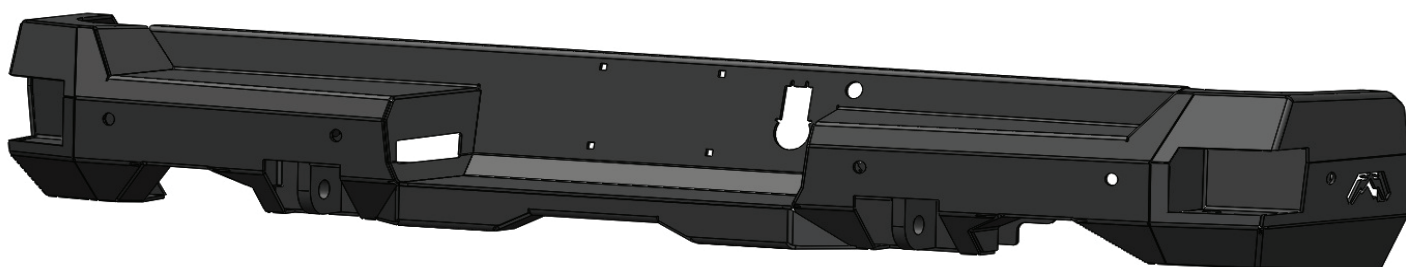

# PROVIDED MATERIALS

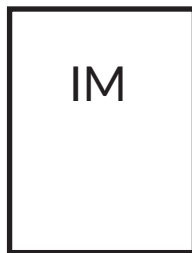

IM

W4251-IM

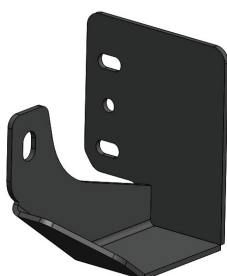

21843



21844



HW  
Kit

50170-HW

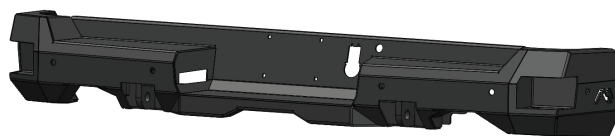

21842

## HARDWARE KIT | 50170

FAB FOURS IDENTIFICATION	COMPONENT DESCRIPTION	QTY
50170-HW	7/16"-18 x 1 1/2", yellow zinc, hex cap screw, grade 8	4
50170-HW	7/16", yellow zinc, lock washer, grade 8	4
50170-HW	7/16", yellow zinc, flat washer, grade 8	8
50170-HW	7/16"-18, yellow zinc, hex nut, grade 8	4
50170-HW	License plate nut inserts, nylon	4
50170-HW	1/2"-13 x 1 1/2", Bolt Yellow Zinc	2
50170-HW	1/2"-13 Nut Yellow Zinc	2
50170-HW	1/2" Lock Washer Yellow Zinc	2
50170-HW	1/2" Flat Washer Yellow Zinc	4
50170-HW	Snap-in Round Plugs	6
50170-HW	#8-32 Stainless Steel Bolt	4
50170-HW	#8-32 Nylock Hex Nut	4
50170-HW	#8-32 Stainless Steel Flat Washers	4

## TOOLS REQUIRED

- Plastic panel pry tool
- Flat head screw driver
- 5/8" socket wrench
- 11/16" deep socket wrench
- 3/4" socket wrench
- 7mm socket wrench
- 9mm socket wrench
- 10mm socket wrench
- 15mm socket wrench
- 16mm socket wrench
- 3/32" allen wrench
- Rubber mallet
- Zip-ties

## ASSISTANCE

We recommend two people perform the installation as items are heavy and may need to be held in place while installing.

## ORGANIZATION

Disassemble the vehicle where you can catalog and store everything. We suggest labeling and bagging all the OEM bolts when removing from the vehicle. Failure to keep track of parts could lead to an inability to properly reinstall components.

# DISASSEMBLY

1. Using the appropriate screwdriver or socket, remove the license plate.

2. Using a 15mm socket wrench, remove the two (2) bolts behind the license plate (Figure 1).



Figure 1

3. Disconnect the rear bumper wiring harness at the quick disconnect by pulling out on the yellow lock tab (Figure 2) and extracting the red lock bar from the housing (Figure 3).



Figure 2

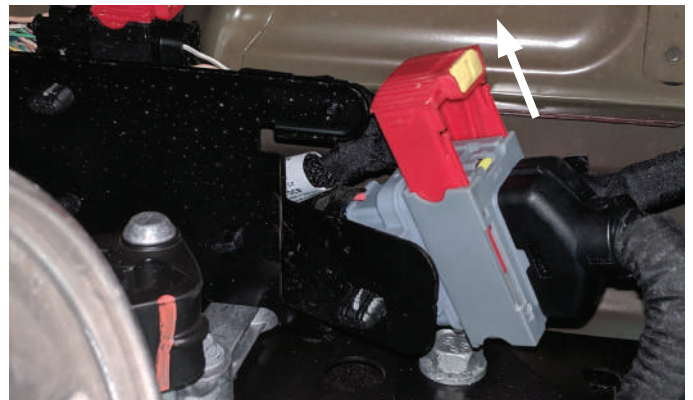

Figure 3



**4. Using a plastic panel pry panel tool, remove the wiring harness from the frame rail. (Figure 4)**



*Figure 4*

**5. With assistance, hold the bumper securely to the frame rail. Using a 16mm socket wrench, remove the four (4) OEM bumper nuts. (Figure 5)**

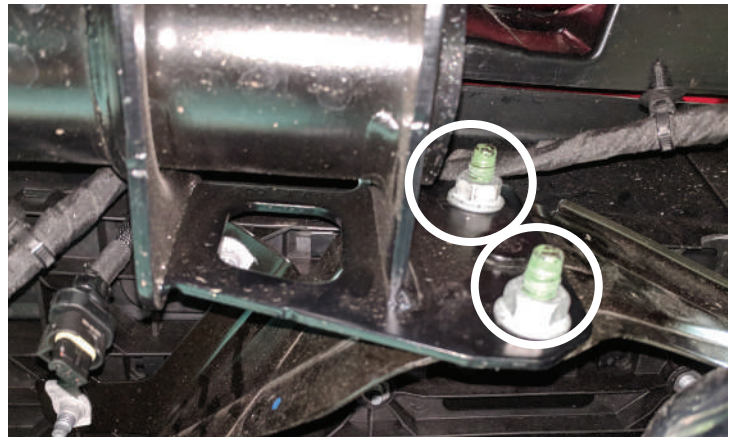
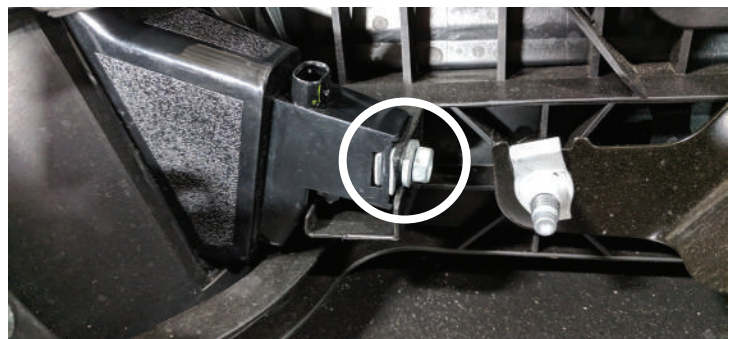

*Figure 5*

**6. Remove the factory bumper and set aside for extraction of license plate lights, sensors, trailer plug, and key-less entry module.**

**7. Disconnect the factory wiring harness from all sensors, license plate lights and trailer plug.**

**8. Using a 10mm socket, remove the factory license plate lights and set aside. (Figure 6)**



*Figure 6*



**9. Remove the bumper stomp cover.  
(Figure 7)**

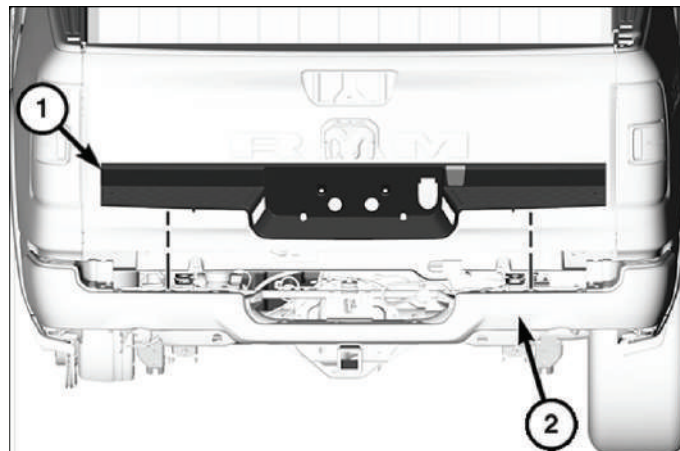

*Figure 7*

**10. Using a 7mm socket wrench, disconnect the factory wiring harness from the keyless entry module and remove the module.  
(Figure 8)**

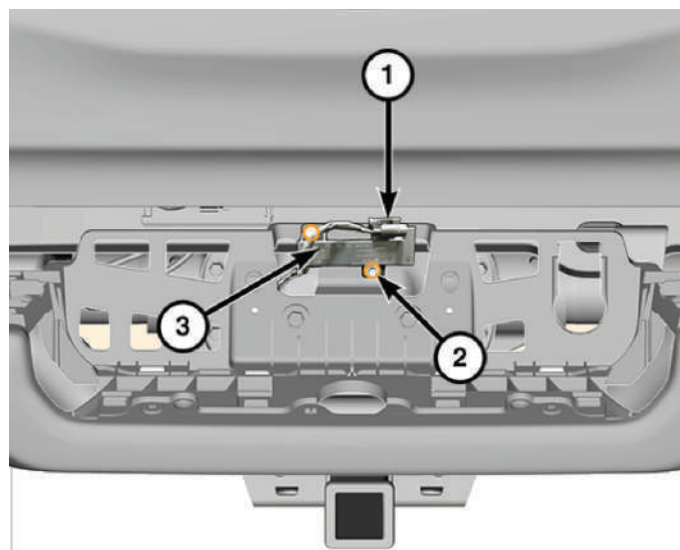

*Figure 8*

**11. Remove the sensors from the sensor housings by expanding both sides of the sensor housing and lifting the sensor up. (Figure 9-10)**

*NOTE: Sensors are extremely delicate and must be handled with care! Do not push on face of sensors to remove!*

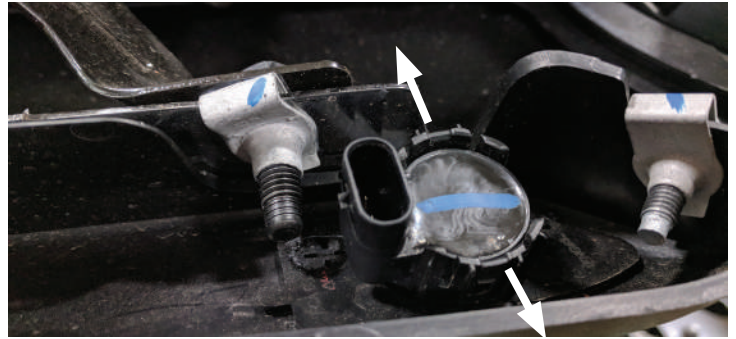

Figure 9



Figure 10

**12. Remove the trailer plug by compressing the two (2) chrome spring tabs and extracting the plug from the bumper shell. (Figure 11)**

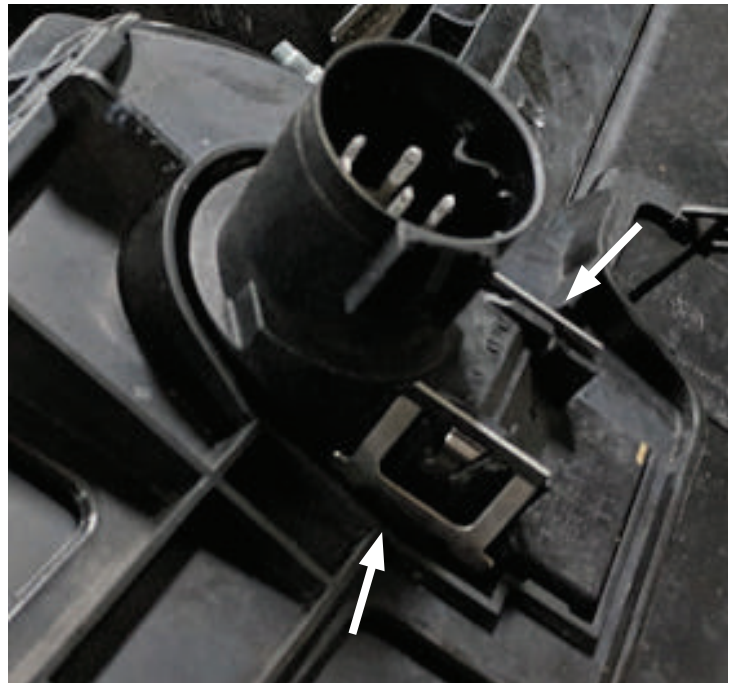

Figure 11

---

**13. Using a plastic panel pry tool, remove the factory wiring harness from the bumper shell. Unclip the nineteen (19) ribbed shank push-in rivets and three (3) panel clips.**



*Figure 12*



# INSTALLATION

---

1. Install the factory trailer plug into the cutout in the license plate area. Using a 1/4" drill bit, drill four (4) holes into the trailer plug connector. (Figure 13-14)

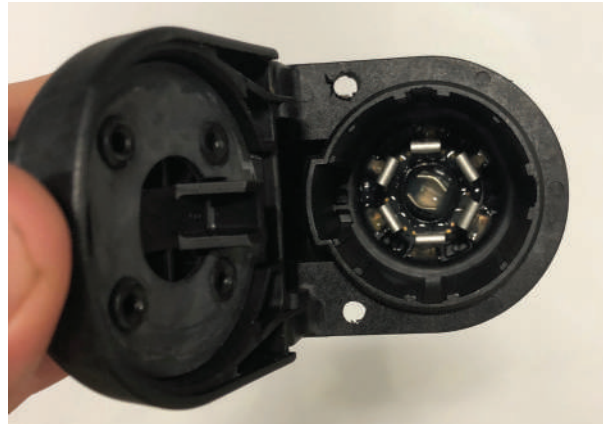

Figure 13



Figure 14

2. Using a 3/32" Allen wrench and 9mm socket wrench, attach the trailer plug to the bumper with the provided four (4) #8-32 stainless steel bolts, nylock nuts and washers (50170-HW) (Figure 15)



Figure 15

**3. Fish the factory wiring harness through the bumper mount cutouts prior to installing the sensors. (Figure 16)**

*Note: Make sure the wiring harness plug is located on the Driver side of the bumper when installing.*



Figure 16

**4. Plug the trailer plug connector into the trailer plug. (Figure 17)**

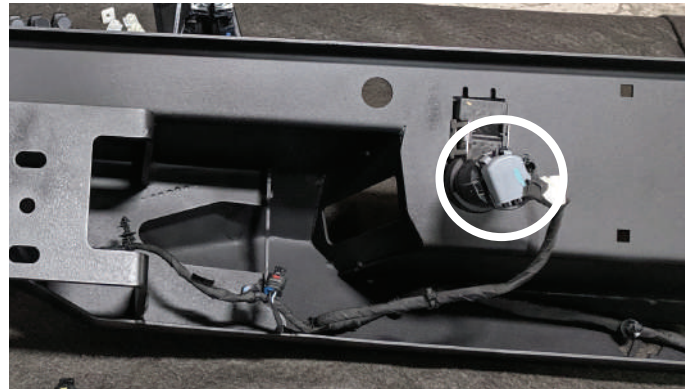

Figure 17

**5. Using a flat head screwdriver, slightly bend out the side tabs on all sensor cups to allow for easy insertion and minimize possible damage to sensor. (Figure 18)**



Figure 18

*Note: (Figure 19) shows the inside of the driver side wing and is intended to illustrate the sensor orientation for both the inner and outer sensors on that side. Both sensors in the passenger side will install with the same orientation.*

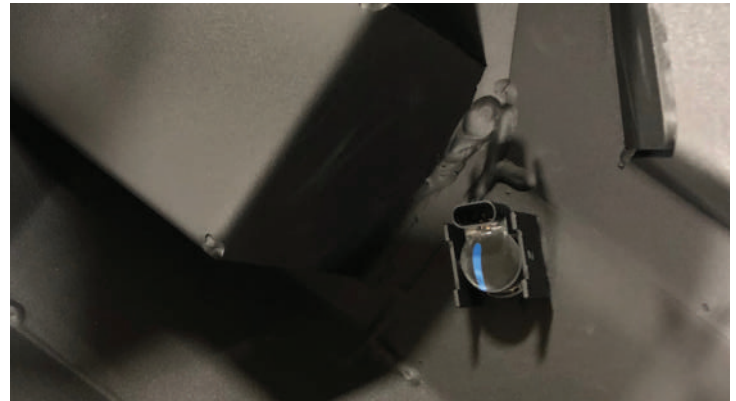

Figure 19

**6. Fully seat the sensor into the sensor cup. Be mindful of the sensor alignment as viewed from the outside of the shell. (Figure 20)**

*Note: The rubber seat of the sensor must not be pinched or distorted in any way for proper sensor installation. Failure to use the rubber seat or pinching of the sensor may result in false readings or non-responsive sensors. The sensor rubber seat is indicated in Figure 20.*

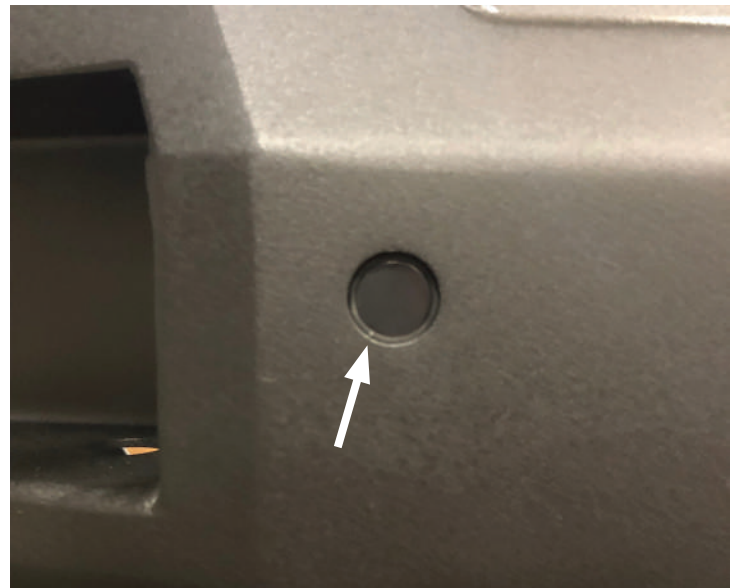

Figure 20

**7. While holding the sensor fully seated in the hole and sensor tabs aligned with the cutouts in the sensor cup bracket, bend the sensor cup bracket tabs back into place and tight to the sensor body. (Figure 21)**

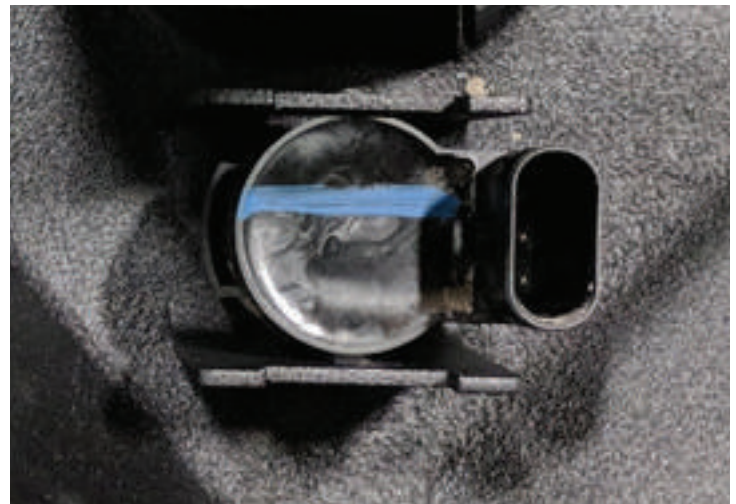

Figure 21



**8. Follow the same installation method for all six (6) sensors being mindful of sensor orientation.**

*Note: If your OEM bumper doesn't have all six sensors, then install the black plastic plugs in the unused sensor holes.*

**9. Using a rubber mallet, align the plastic plug and hammer handle square with the sensor hole. (50170-HW) (Figure 22)**



Figure 22

**10. Firmly slap the hammer head with your hand to seat the plastic plug in the hole. (Figure 23)**



Figure 23

**11. Using a 10mm socket wrench, reinstall both license plate lights into the bumper using the OEM hardware to secure the lights to the bumper.**

*Note: Don't over tighten the two (2) factory license plate light bolts as you may crack the plastic light. Only snug up the light hardware. Locktight is recommended for these two bolts*

**12. Reconnect the factory wiring harness to all six (6) of the sensors and both license plate lights.**

*Note: Zip tie holes are provided in four (4) places along the inside of the shell to secure the factory wiring harness. The four (4) locations are two (2) above the outer sensor and two (2) on the license plate light bolt plate. Outer zip tie location and example shown in Figure 24.*



Figure 24

**13. Zip tie or secure the key-less entry module to the frame located right behind where the license plate mounts. (Figure 25)**



Figure 25

14. Using a 3/4" socket wrench, install the provided mounting brackets (21843, 21844) onto frame rails with the provided two (2) 1/2" yellow zinc bolts with two flat washers, lock washer and nuts. (50170-HW) (Figure 26)

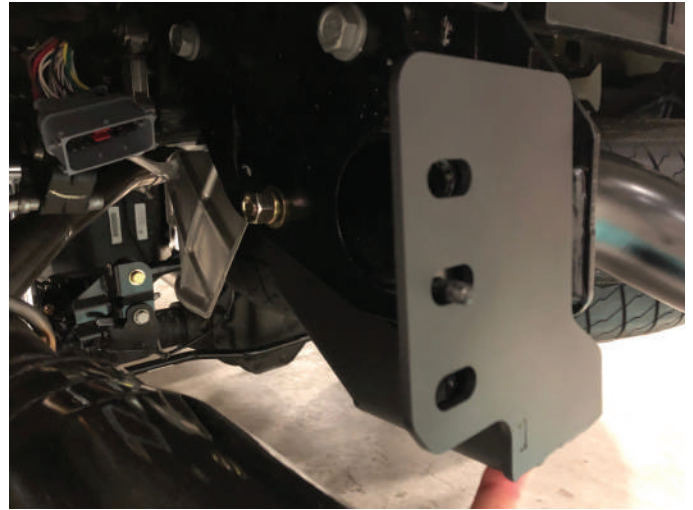

Figure 26

15. Using a 5/8" socket wrench and 11/16" deep socket, loosely install the provided four (4) sets of 7/16" yellow zinc hex head bolt, two flat washers, lock washer, and nut bolt stacks into the driver and passenger side frame rail end. (50170-HW) (Figure 27)



Figure 27



---

**16. Reconnect the factory wiring harness main connector to the vehicle where it was disconnected from in step 2 of the disassembly section and re-plug the ribbed shank push-in rivets into the frame rail.**

**17. Insert the provided four (4) nylon license plate nut inserts into the four holes on the bumper. (50170-HW) (Figure 28)**



*Figure 28*

---

**“IF YOU’RE LOOKING FOR MORE OF THE SAME,  
THEN YOU’VE COME TO THE WRONG PLACE.”**

**- GREG HIGGS**

