

## COMP SERIES REAR BUMPER

21+ FORD BRONCO

RBBR-04



### TOOLS REQUIRED

- 13mm,16mm,18mm Socket
- 10, 16mm Wrench
- Lug Nut Tool
- 4mm Allen Bit
- Philips Head Screw Driver
- Electrical Crimping Tool
- Scissors or Snips
- Trim Piece Removal Tool

### SKILL LEVEL

- Novice/Intermediate
- 1 to 2 People

Little skill level required, you can easily assemble this by yourself, however will need assistance for installation--minor wiring required.

### TIME REQUIRED

- Approximately 4 Hours

Time to install this should take about 4 hours

## WARNINGS/CAUTIONS BEFORE STARTING INSTALLATION

Before you install this kit – Read and understand all instructions, warnings, cautions, and notes contained in this installation instruction guide. Consult your vehicle owner’s manual for proper disconnection of electrical and lifting of vehicle if required for installation of this product.

This install may require some technical skills and knowledge of basic mechanical work. If you do not feel that you are capable of performing this install please take this product to a trained professional.

After reading this guide please contact us with any questions or concerns before installing product.  
Customer Service: 855-680-9595

*DV8 Offroad is not responsible for any bodily injury or harm to you or your vehicle as a result of an improper install.*

Proper installation of this kit required knowledge of the factory recommended procedures for removal and installation of original equipment components. We recommend that the factory shop manual and any special tools needed to service your vehicle be on hand during the installation. Installation of this kit without proper knowledge of the factory recommended procedures may affect the performance of these components and the safety of the vehicle

- Always wear eye protection when operating power tools

*Inspect all contents of this package to make sure product is not damaged and all installation hardware has been included. If parts are missing from kit, please be prepared to provide the following information*

1. Name of purchase location
2. Bar Code on side of box
3. Date above bar code
4. Date inside box cover



# INSTALLATION MANUAL

## STEP 1

Unplug the factory bumper from the Bronco. Locate the small plug just to the rear of the rear wheel wells on each side of the bumper.



## STEP 2

Using a 13mm socket, unbolt the side bumper supports on each side of the bumper just outside of the frame rails.



## STEP 3

Remove the lower four bumper bolts using a 18mm socket.

*Note: When you do this, the bumper can become free from the vehicle and can fall. Ensure you have another person holding it, or the bumper secure to prevent falling and injury.*



# INSTALLATION MANUAL

## STEP 4

Once bumper is removed, lay on soft surface face down. Unclip the license plate light by squeezing the plug and pulling away from the bumper.

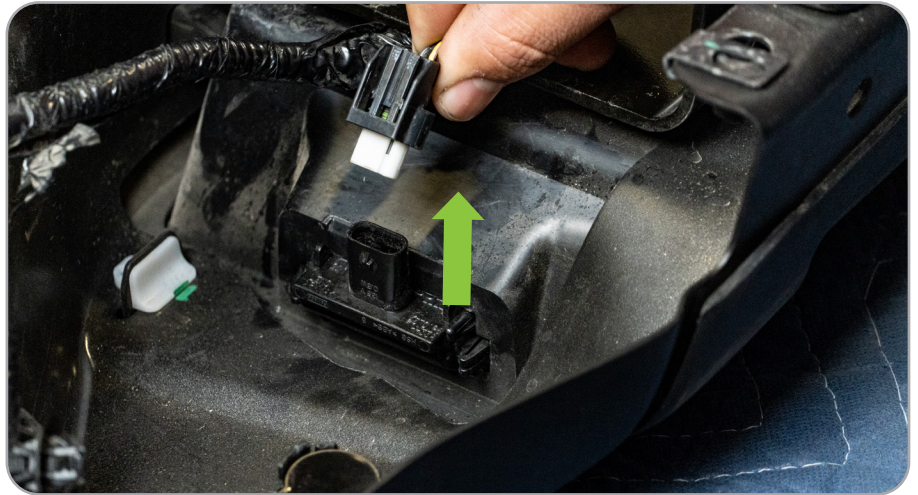

## STEP 5

Remove the thirteen bolts holding the three center brackets using a 13mm socket.

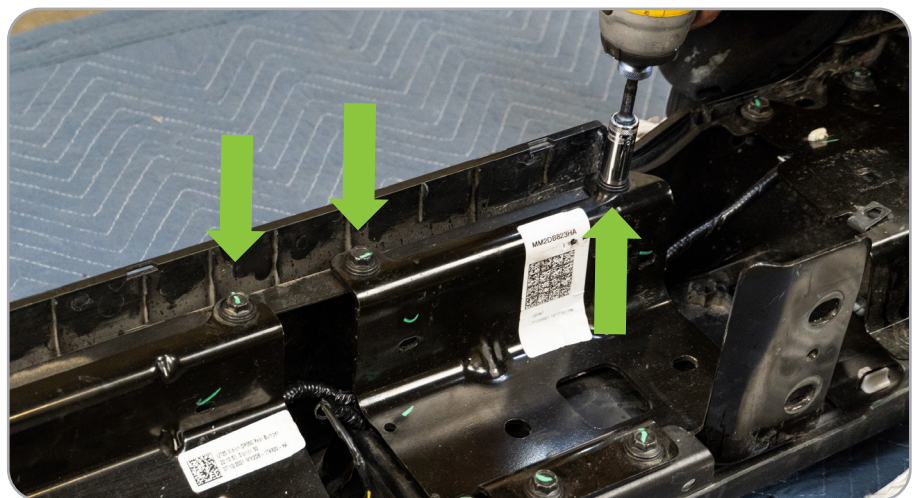
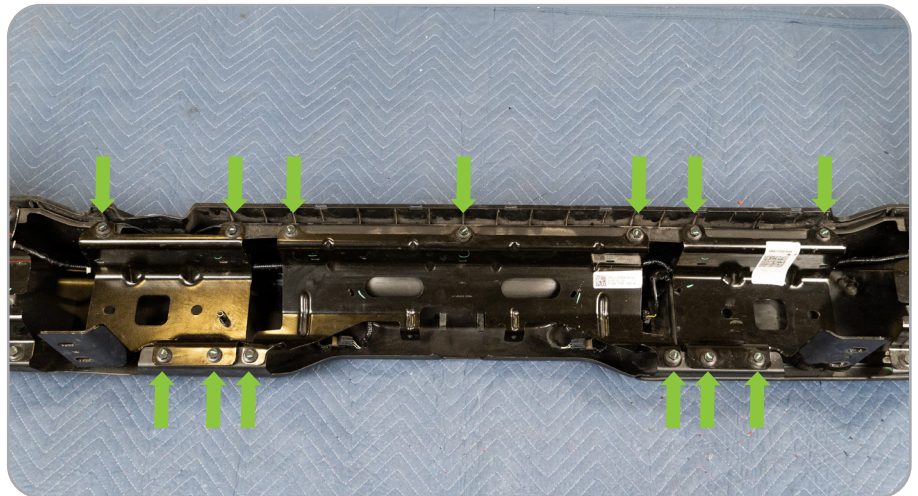

# INSTALLATION MANUAL

## STEP 6

Using a push pin removal tool, remove point where the wire harness is connected to the bumper or brackets.



## STEP 7

Remove the two center sensors from the sensor bezels by spreading the two tabs on the bezels and pull the sensor up.

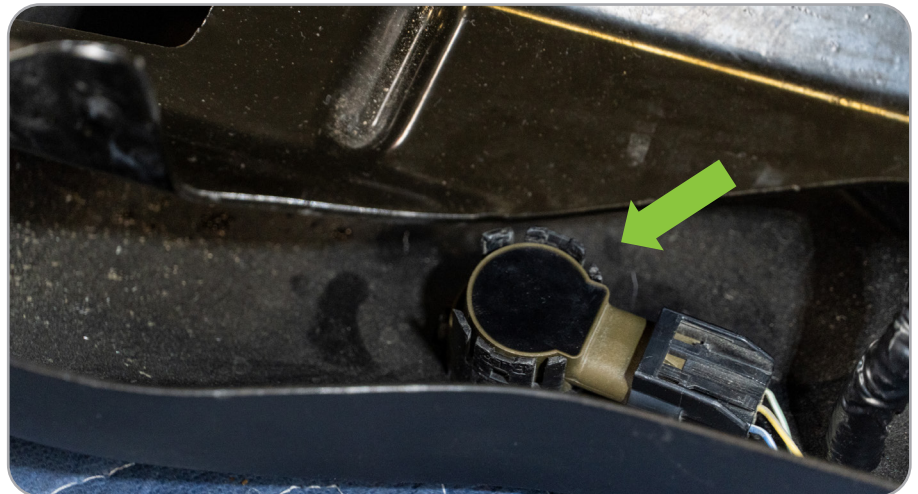

## STEP 8

To remove the outer sensors, spread the tabs on the inner gray sensor bezel to release the sensor, and once removed, squeeze the same tab while pulling the face of the bezel on the outside to release the bezel from the white cage.

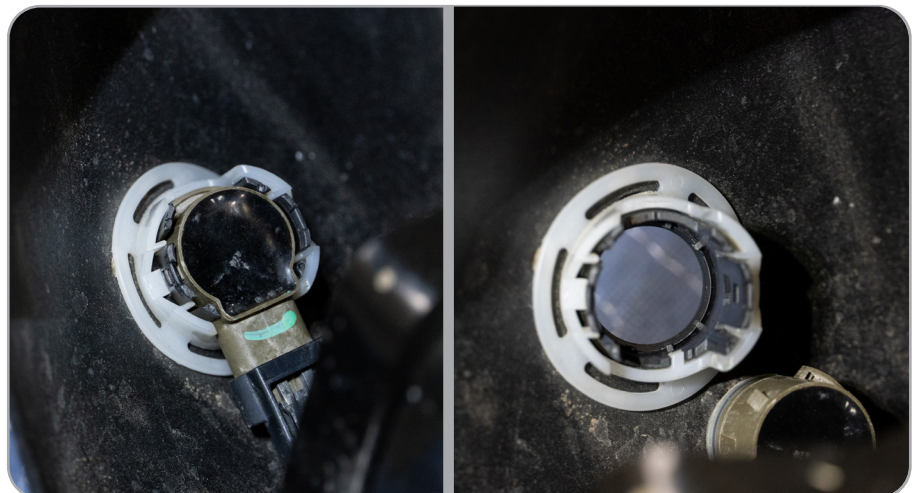

# INSTALLATION MANUAL

## STEP 9

Lean the bumper forward, and while pulling the face of the sensor bezel from the outside of the bumper, squeeze the two tabs on the bezel near the bumper to remove the bezel.



## STEP 10

Carefully, pull the wire harness away to be used on your new DV8 bumper.

*You are now done with the removal of your Bronco bumper.*



# INSTALLATION MANUAL

## STEP 1

Begin by unpacking all items and inspecting for missing pieces or damage. If you have any concerns, please contact the company the product was purchased from.

<b>Hardware Included:</b>	(4) M6 Lock Nuts
(4) M14x35mm Bolts	(8) M6 Flat Washers
(4) M14 Nuts	(4) M10 Nut Clips
(4) M14 Split Nuts	(4) M10x30
(8) M14 Flat Washers	(4) M10 Flat Washers
(4) M6x20mm Bolts	(4) M10 Split Washers

**Extra hardware may be included but not utilized.**

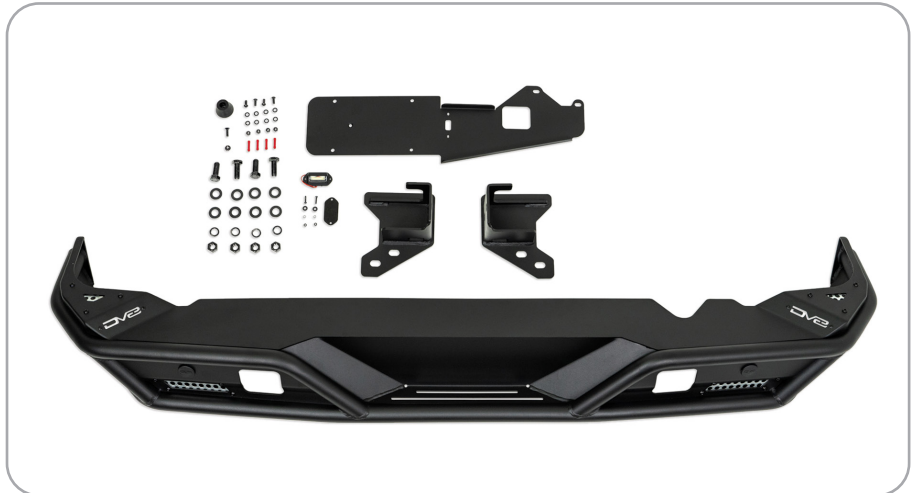

## STEP 2

Begin by laying the bumper face down on a soft surface to prevent damaging the face. Feed the harness through the opening in the bumpers so that all sensors lay near their respective openings. Secure harness to bumper using zip ties on welded-in zip tie tabs



# INSTALLATION MANUAL

## STEP 3

To install the sensor bezels into the bumper, identify the location of the bezel by reading the identifier on the bezel. For example, our image shows “ROR” which stands for rear outer right.

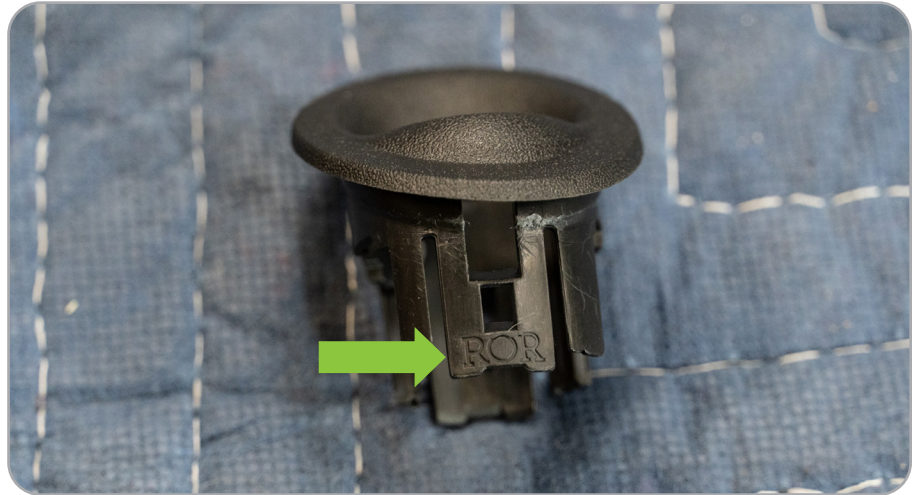

## STEP 4

On the two center bezels, you may need to trim down the tabs on the side to allow for the thicker material our bumper uses. Trim slightly and test fit until these tabs sit on the backside of the bumper and the bezel sit flush to the face of the bumper.

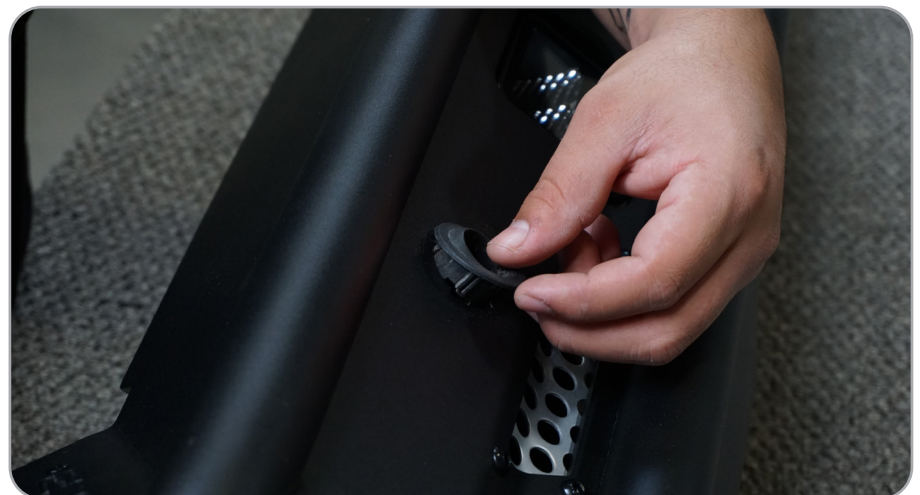

# INSTALLATION MANUAL

## STEP 5

Lean the bumper back and fit the two inner sensor bezels into place.

*Note: Our bumpers are designed to accept both factory metal bumper and plastic bumper sensor bezels. All cutouts are cut differently to ensure each bezel is placed into the correct hole*



## STEP 6

Install the sensors by holding the face of the bezel and clicking the sensor into place.

*Note: If the sensor will not click into place easily, you may need to trim the tabs more from step 4.*





# INSTALLATION MANUAL

## STEP 7

The thickness of our bumpers will not allow you to reuse the outer bezel cages, so after you install the sensor into the bezel, using a zip tie, tighten around the sensor and bezel while pushing zip tie up against bumper. You can also utilize a small dab of silicone between the backside of the bezel and the front face of the bumper.

*Note: On the DV8 bumper, these should be oriented down.*



## STEP 8

For the two center sensors, you will need to cut back or unpeel the wiring loom of the bumper wiring harness. Once the wiring is exposed gently pull the two center sensors away from each other. This will create extra length in the harness needed for all sensors to reach their install location. Cover wiring with electrical tape or sleeve.



# INSTALLATION MANUAL

## STEP 9

We are installing two 3" pods using the hardware provided with the light. (Not included).

*Note: We are running two 3" Flush Mount DV8 elite lights.*



## STEP 10

Using the four provided M10 nut clips, place them on the bumper with the flat side showing. They should snap into place if seated correctly.

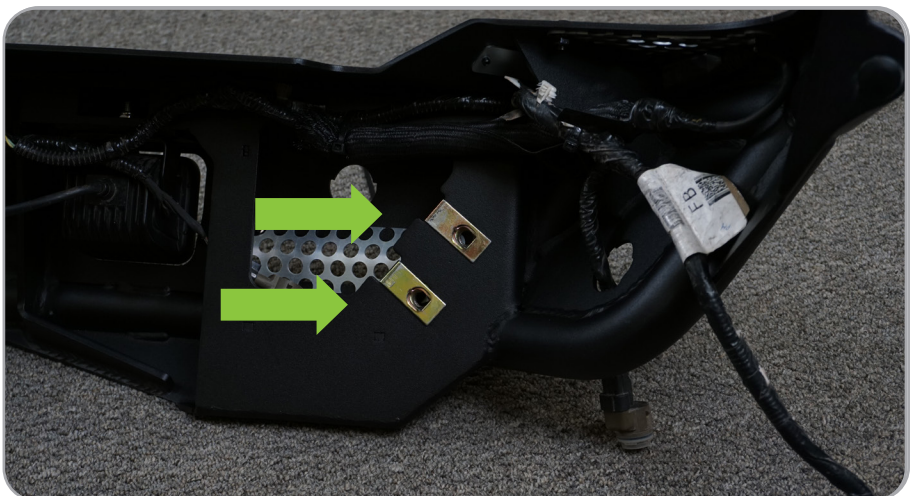

# INSTALLATION MANUAL

## STEP 11

Loosely attach the bumper mounts onto the bumper with the included M10 hardware and a 16mm socket/wrench.

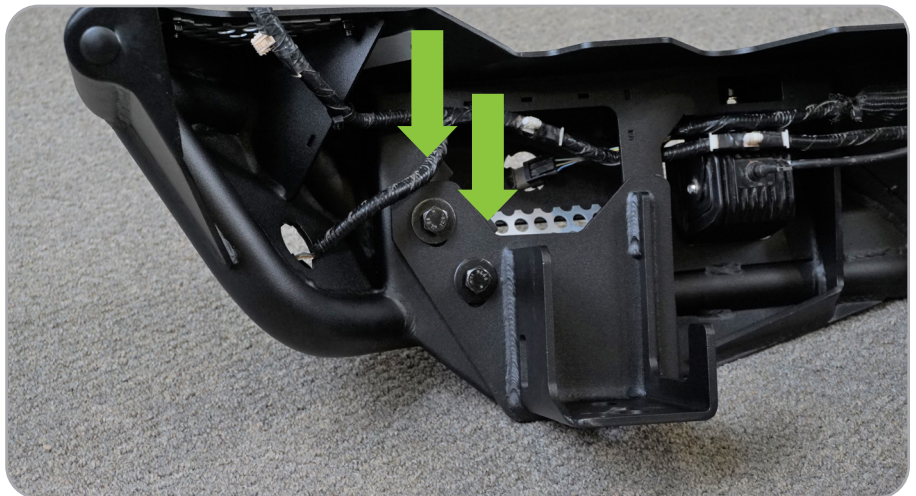
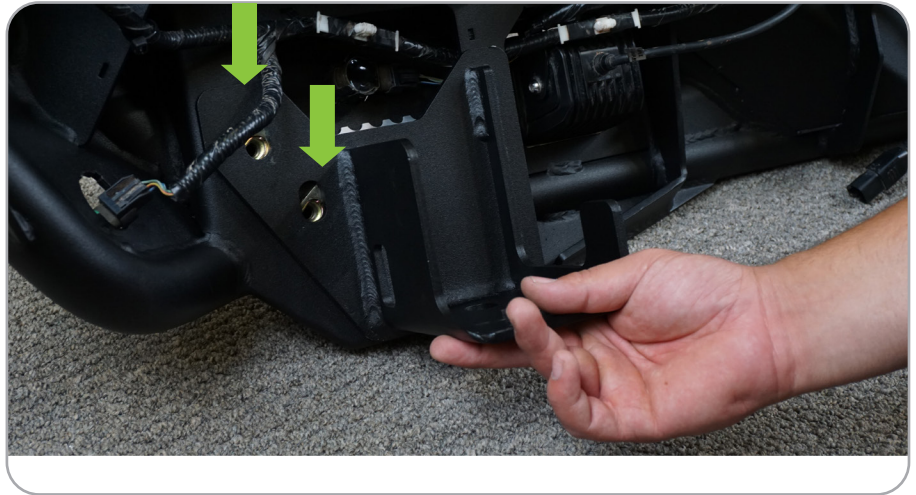

# INSTALLATION MANUAL

## STEP 12

Lift the bumper to the vehicle with assistance to prevent any damage to the vehicle or the bumper.

Using the factory M12 hardware and 18mm socket, secure the bumper brackets to the Bronco to 70ft lbs.



# INSTALLATION MANUAL

## STEP 13

Adjust and align the bumper and using a 16mm wrench, tighten down the bumper to the bumper brackets until secure.

Plug in both rear wire harness plugs located just above each corner of the bumper.

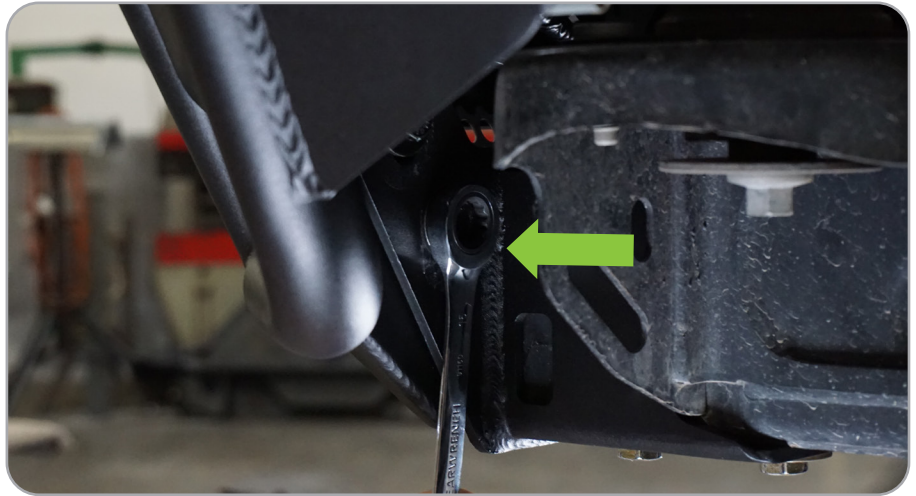

## STEP 14

You are finished with the install of the bumper. See the following steps for install of the license plate bracket.



# INSTALLATION MANUAL

## STEP 15

Start by installing your license plate onto the relocation bracket using the provided M6 hardware with a 4mm allen bit and a 10mm wrench.



## STEP 16

Drop the provided M6 serrated nut into the rubber bumper and install onto the license plate bracket using the provided M6x20 hardware and a 4mm allen bit.



# INSTALLATION MANUAL

## STEP 17

Peel the paper off the provided foam and install onto the license plate light by sliding the wires through the foam.



## STEP 18

Install the license plate light onto the bracket with the light facing the license plate. Use the provided M4x15 hardware with a Philips head screwdriver.



## STEP 19

Using provided wire butt connectors, connect the license plate light to the provided wiring.



# INSTALLATION MANUAL

## STEP 20

Moving to the Bronco, remove the lug nuts from the spare tire carrier using a lug nut tool and remove the spare tire.

*Note: Assistance is recommended for removing the spare tire to prevent injury or damage.*



## STEP 21

Remove the two factory bolts on the bottom driver corners of the spare tire carrier using a 13mm socket.

*Note: This is shown with our TCBR-01 backing plate. This bracket is compatible **with and without** the TCBR-01 carrier installed.*



## STEP 22

Loosely install the license plate bracket onto the vehicle utilizing the factory hardware and 13mm socket. Ensure the wiring will not be pinched between the bracket and vehicle.

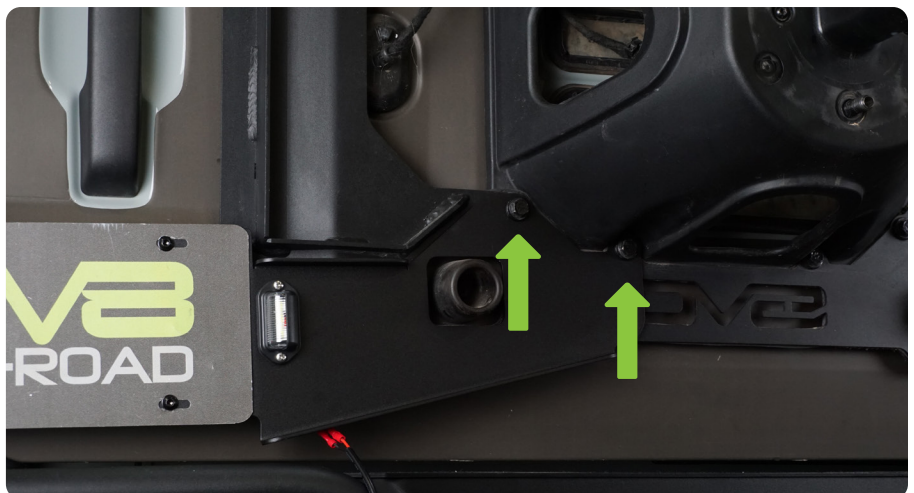



# INSTALLATION MANUAL

## STEP 23

To run the wire behind the spare tire carrier and through the vent in the tailgate it may be necessary to loosen one or two additional bolts of the tire carrier to create clearance for the wire.



## STEP 24

Open the tailgate and remove the trim piece of the interior of the tailgate using a trim piece removal tool.

Unclip the fasteners on the bottom of the long trim and slide it down to remove.

Unclip the fasteners on the passenger side of the wide trim and slide to the passenger side to remove.



# INSTALLATION MANUAL

## STEP 25

Feed the wire through the vent in the tailgate while reaching inside the tailgate and feeding out of either of the “accessory ready” holes. You may choose to secure the wire to the existing wiring loom with zip ties for a cleaner feel.



## STEP 26

Partially remove the trim piece to the passenger wall of the trunk closest to the tailgate by pulling up on the bottom and out on the sides. Use a trim piece removal tool if necessary.



## STEP 27

Remove the trim piece behind the compartment for the factory jack by pulling up on it. Use a trim piece removal tool if necessary. Run the wire down the sidewall and along the bottom of the interior.

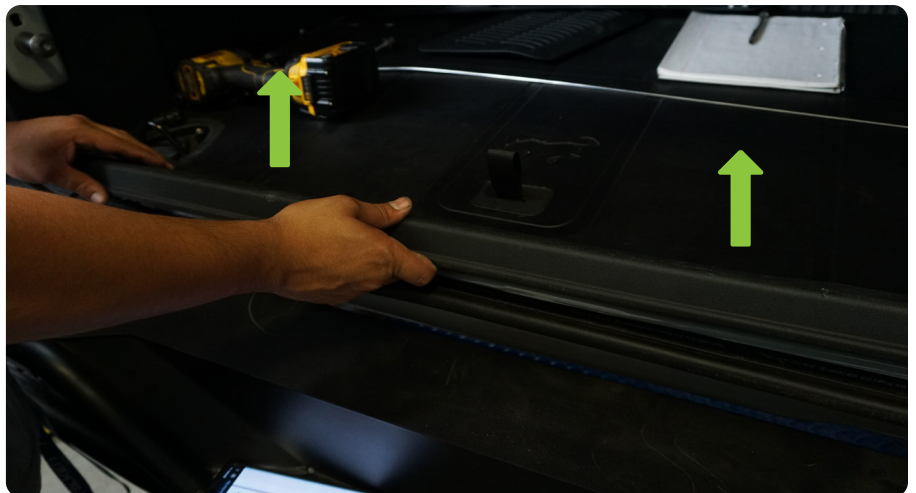

# INSTALLATION MANUAL

## STEP 28

Partially remove a section of the weatherstripping along the bottom of the trunk, near to the driver side of the vehicle and feed the wire through.

Replace the weatherstripping and all interior trim panels when finished. Finish running the wire behind the bumper to where factory license plate light wiring is located.



## STEP 29

Disconnect the battery to prepare for splicing wires.

If you have a lot of excessive wire, trim it to an appropriate length. Snip the factory license plate wiring to splice the new license plate wiring. *If you wish to keep the quick disconnect wiring solution, be sure to cut the wires after this connection, so that it will remain on the vehicle.* This will allow for easy connection and disconnection.

Reconnect battery when finished.

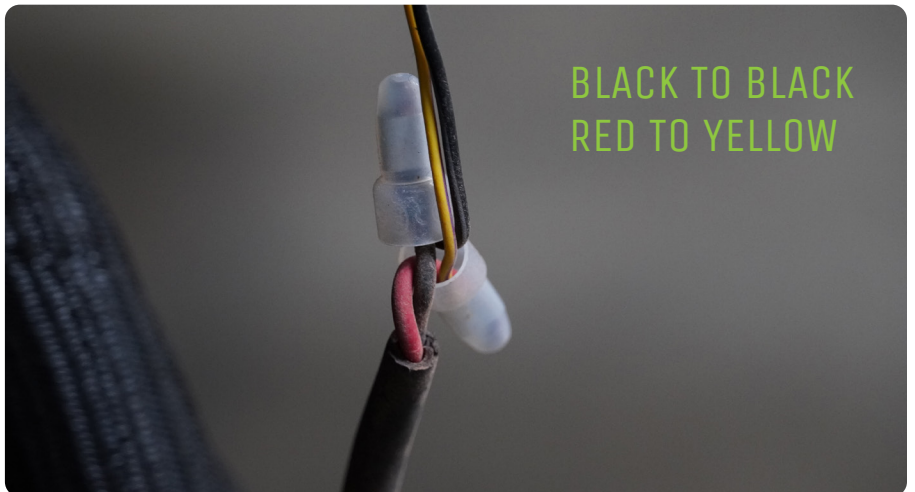

## STEP 30

Finish securing spare tire carrier bolts securing the license plate relocation bracket using a 13mm socket. If you loosened bolts to create clearance for the wire, re-tighten these also with a 13mm socket.

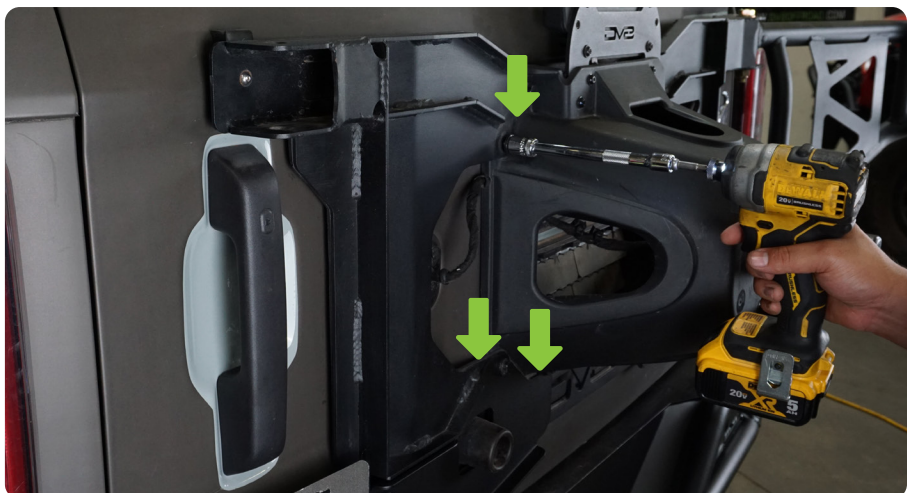

# INSTALLATION MANUAL

## STEP 31

Double check fitment and all hardware is secure.

Double check function of the lights.

Congratulations, you are finished with the install of your 21+ Bronco License Plate Bracket and Comp Series Rear Bumper.

