



# DSTC BUMPER

## 2022+ TOYOTA TUNDRA



## INSTALL GUIDE

EXP265

### PLEASE READ ENTIRE GUIDE BEFORE INSTALLATION

Recommended that you read this entire install guide before installation. Check that all hardware is present before starting or scheduling an install. This guide is supplemental to mechanical knowledge and ability. Anyone not familiar with automotive installation should seek professional installation.

LAST UPDATE 9/12/23 v1



# INSTALL GUIDE

## IMPORTANT INFO/FAQ

### INSTALL GUIDE

ALL

#### INSTALLATION HELP

Please review terms and conditions for details

Recommended purchaser review Welcome Guide at time of purchase for details

Care and Maintenance available at [www.exp-one.com/resources](http://www.exp-one.com/resources)

We do our best to offer timely assistance with your installation questions however as most of our team members are primarily engaged in the manufacturing process and packaging processes, we do not currently offer a tech for on-demand calls and inquiries. For the more technical installs or installs that are time-sensitive in nature, we would recommend our customers seek out the services of professional shops with experience specific to aftermarket bumpers that can better meet your needs. We are happy to make recommendations to you on shops familiar with our products in your area. We do our best to respond to installation questions within 24-48 hours of contact as much as possible. Long-distance problem assessment can be difficult, so photos and videos are often required for us to best assist you. We highly recommend your initial contact regarding installation questions include both close-up and full photos, detailed descriptions using our part descriptions as much as possible, and video. This enables us to better assist without having the ability to see the install difficulties directly and assist you as quickly as possible.

#### NOTE

Expedition One does not guarantee fitment with other aftermarket products, or reinstallation of take off OEM parts.

Expedition One is NOT RESPONSIBLE for damage to paint or powder coating, items assembled in error during installation or costs associated with install

OEM manufacture model refreshes/updates, factory build location and suppliers may cause variations in fitment or installation and can not be verified, vehicle to vehicle .

\*This product contains chemicals known to the state of California to cause birth defects or other reproductive harm. For more information go to [www.p65warnings.gov](http://www.p65warnings.gov)\*

GSA# GS-30F-013CA

EXPEDITION ONE  
113 N. 700 W. BUILDING 5C BAY 1  
OGDEN, UT 84404  
INFO@EXPEDITIONONE.BIZ  
801-627-2921

\*This product contains chemicals known to the state of California to cause birth defects or other reproductive harm. For more information go to [www.p65warnings.gov](http://www.p65warnings.gov)\*

## INSTALL GUIDE

ALL

### LIGHTPORTS

To give you a wide range of options from various brands and designs, the light ports were designed to be as universal as possible. Not all mounts or designs will fit exactly and may require the use of shims, spacers, light manufacture mounts or different hardware to mount. Reuse of OEM light is limited to select bumpers and will come with provided hardware to reinstall. It is recommended that lights be purchased with the bumper in hand to gain the best fitment. We **DO NOT** manufacture the lights, provided wiring, or instructions on how to connect to the OEM harness.

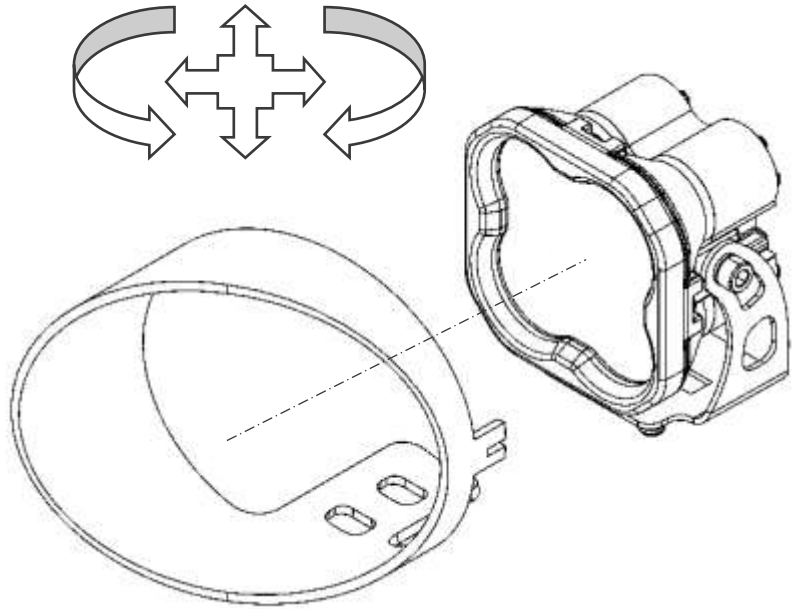

EXAMPLE SHOWN – LIGHT PORTS VARY

### AFTERMARKET or OEM PRODUCTS

We **DO NOT** guarantee fitment or installation of any aftermarket, third party or OEM parts, accessories, or hardware. This includes items such as lighting, winches, skids, lifts, suspension, and accessory mounts. Access to all brands, manufactures and country of origin specific parts is limited or impossible during the product development stage and subsequent new or modified revisions of said products including OEM design changes or refreshes. It is recommended you have the product in hand and installed before modifying with other aftermarket parts. Consult forums or other sources to gain any first hand knowledge of other products others have installed.















### INSTALL GUIDE

ALL

#### HARDWARE

Please review for details and installation. Figures or data may vary. Leave all accessible hardware loose for installation and tighten all hardware after everything is installed on the vehicle. Check and retighten all hardware after the first 100 miles and/or after off roading. **Some hardware locations do not require being tightened to spec due to there design, location or material attachment (including rubber, plastic, and aluminum). Over tightening may break or damage parts. Torque spec may vary, amounts listed are generic.**

HARDWARE		TORQUE SPEC – FT.-LBS.	
SIZE	SOCKET WRENCH	GRADE 5 M- 8.8	GRADE 8 M – 10.9
#8	1/4"	X	
#10	5/16"		
1/4"	7/16"	6-8	9-10
5/16"	1/2"	13-14	18-20
3/8"	9/16"	23-26	33-37
7/16"	5/8"	37-41	52-58
1/2"	3/4"	57-64	80-90
9/16"	13/16"	82-91	115-129
5/8"	15/16"	112-118	159-180
3/4"	1-1/8"	200-223	282-315
7/8"	1-5/16"	322-355	454-501
1"	36MM	X	
M6	10MM	9-10	13-15
M8	13MM	22-24	32-35
M10	15MM	44-49	64-72
M12	18MM	76-83	112-123

TYPES OF HARDWARE		
		
HEX CAP BOLT	WASHER	NYLOC NUT
		
BUTTON HEAD BOLT	FENDER WASHER	HEX NUT
		
CARRIAGE BOLT	INTERNAL TOOTH	JAM NUT
		
SOCKET CAP BOLT	CLIP NUT	ACORN NUT
		
FLAT HEAD SCREW	RIVET NUT	COUPLING



GRADE5



CLASS8.8



GRADE8

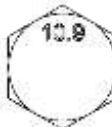

CLASS10.9

**NOTE - Extra hardware may be left over due to model or option specific items that may not be required for the install.**

### INSTALL GUIDE

EXP265

#### BUMPER HARDWARE

A Bumper Mount Bracket 2

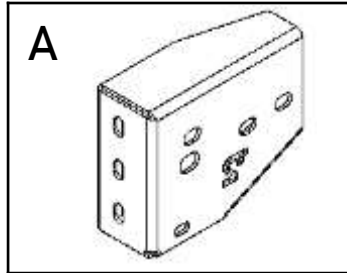

B Bumper Wing Mount Bracket 2

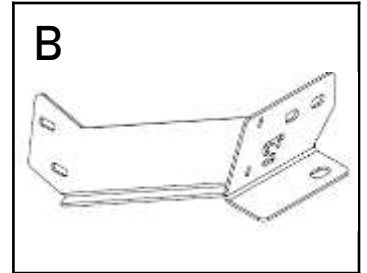

C License Plate Light Brackets 2

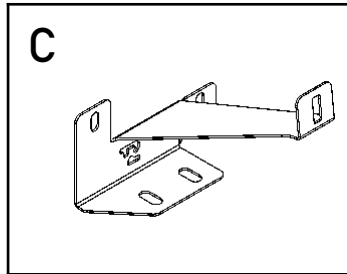

D Light Mount Tabs 2

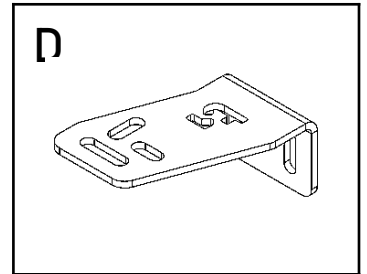

E Sensor Cover 2

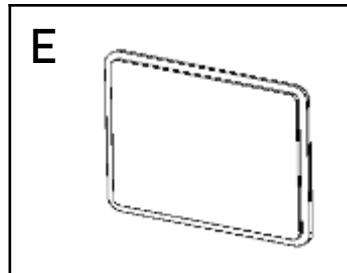

F Sensor Mount 2

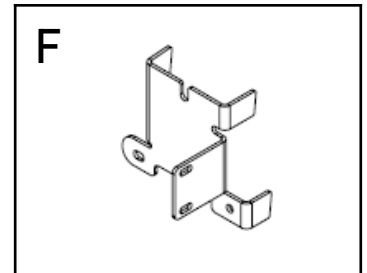

G Fender Mount Bracket 2

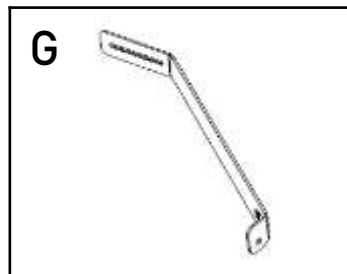

H Fender Mount Bracket 2

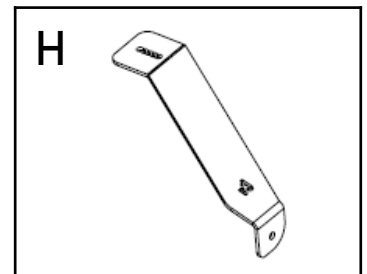

I Wing Mount Nut Retainer 2

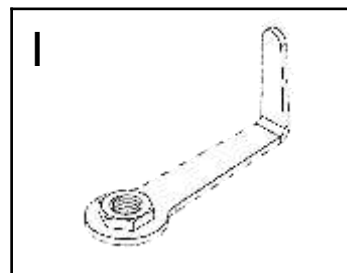

J Wing Mount Double Nut Retainer 2

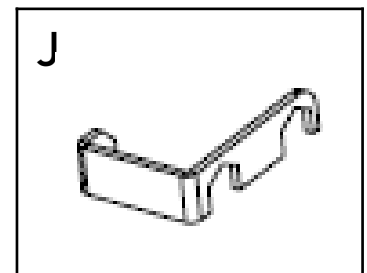

NOTE - Extra hardware may be left over due to model or option specific items that may not be required for the install.

NOTE - Extra hardware may need to be removed due to model or option specific items that were not be present for the models and year specific vehicles used in our install. Check for extra connections before removing hardware.

## 1 - REMOVE OEM BUMPER HARDWARE

Remove the rear bumper OEM hardware from the wheel wells on each side of the vehicle. Extra locations underneath will need to be unbolted. Flex the fender trim (or completely remove the trim) for bumper removal, access and installation.

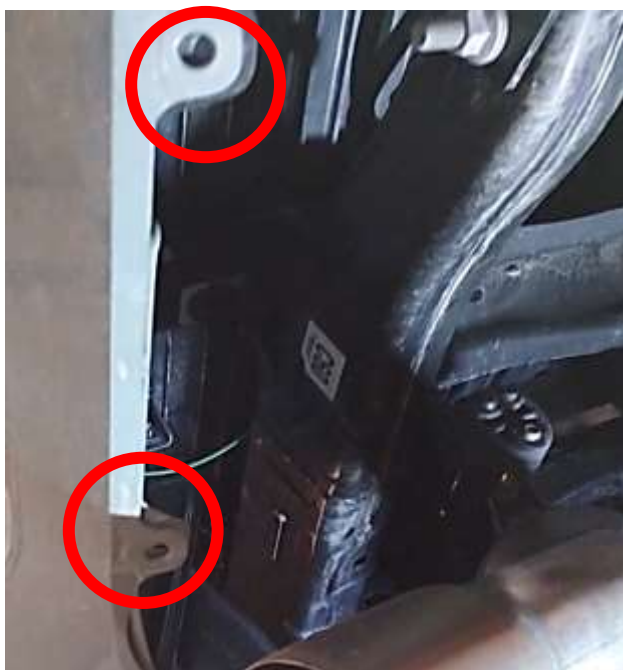
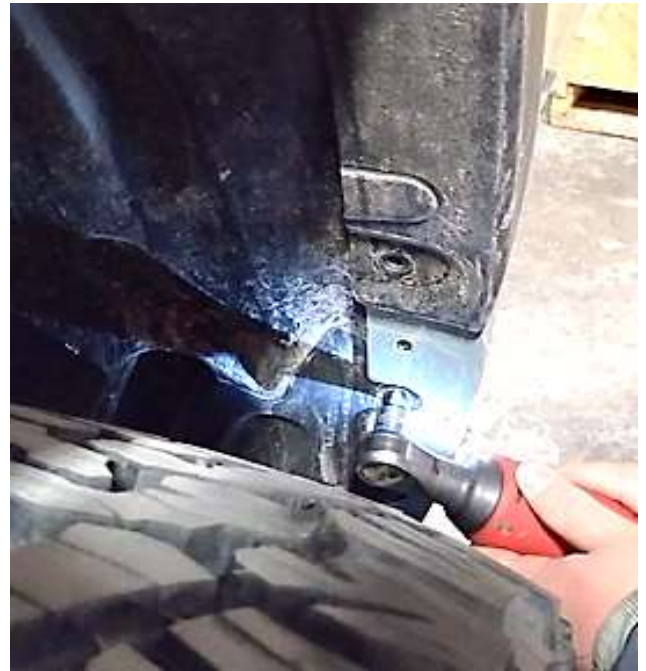

## 2 – BUMPER REMOVAL

Undo the sensor in the side piece and check for any remaining hardware connecting the bumper. Remove the bumper by pulling it away from the corner near the wheel wells.



## 3 – SENSOR REMOVAL

Disconnect the side sensors from the housing, save hardware for later as it will be relocated.



## 4 – SENSOR HOUSING REMOVAL

Unbolt and detach the plastic sensor housing assembly from the fender and center bumper.



## 4 – CONTINUED



## 5 – TREAD PLATE REMOVAL

Pry off the tread plate pieces from the top of the bumper.



## 6 – FASCIA REMOVAL

Un clip the remaining tread top pieces and remove the side fascia's of the bumper.

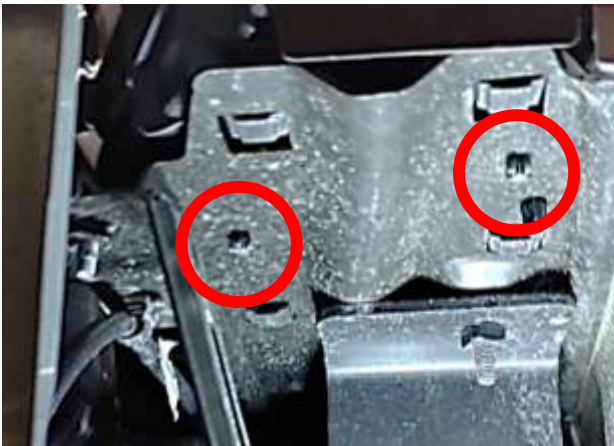



## 7 - CENTER SECTION REMOVAL

Unbolt and detach the remaining center section assembly.



## 8 - BRACE REMOVAL

Cut off the braces and hitch area gusset tops

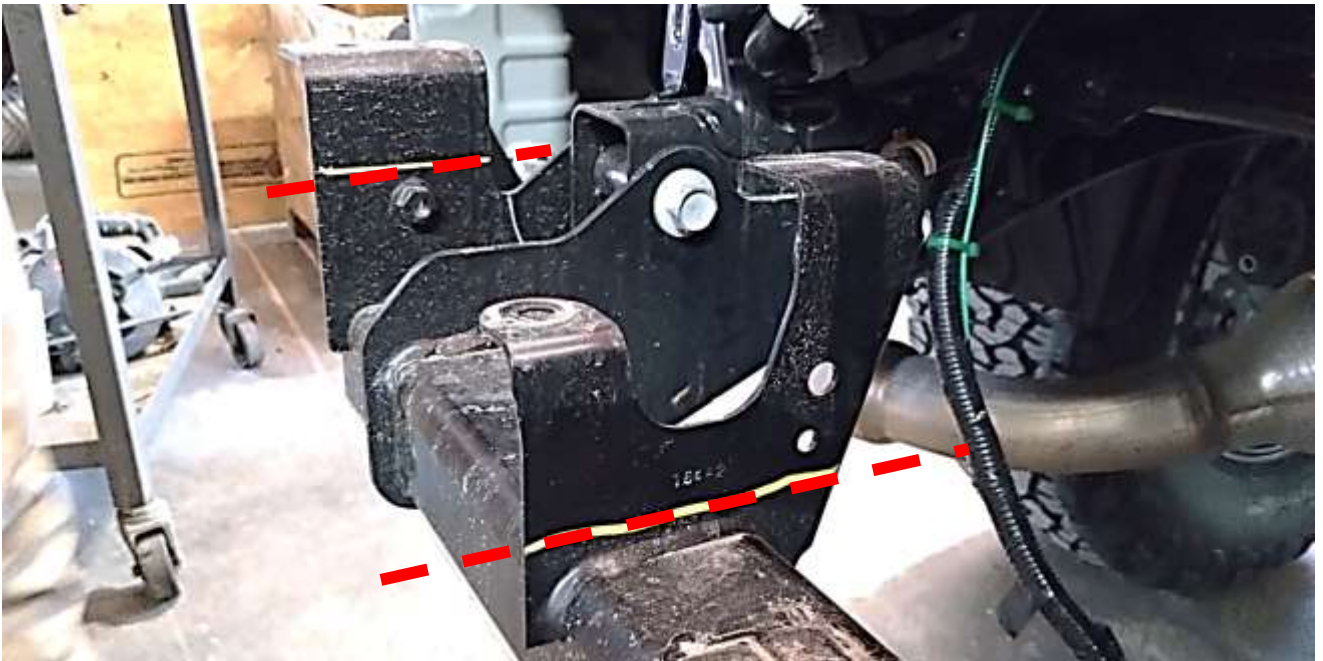

## 9 – FENDER TRIMMING AND CUTTING

Trim the body panel as shown just above the logo. Cut off the corner edge of the wheel well for clearance at installation of the bumper

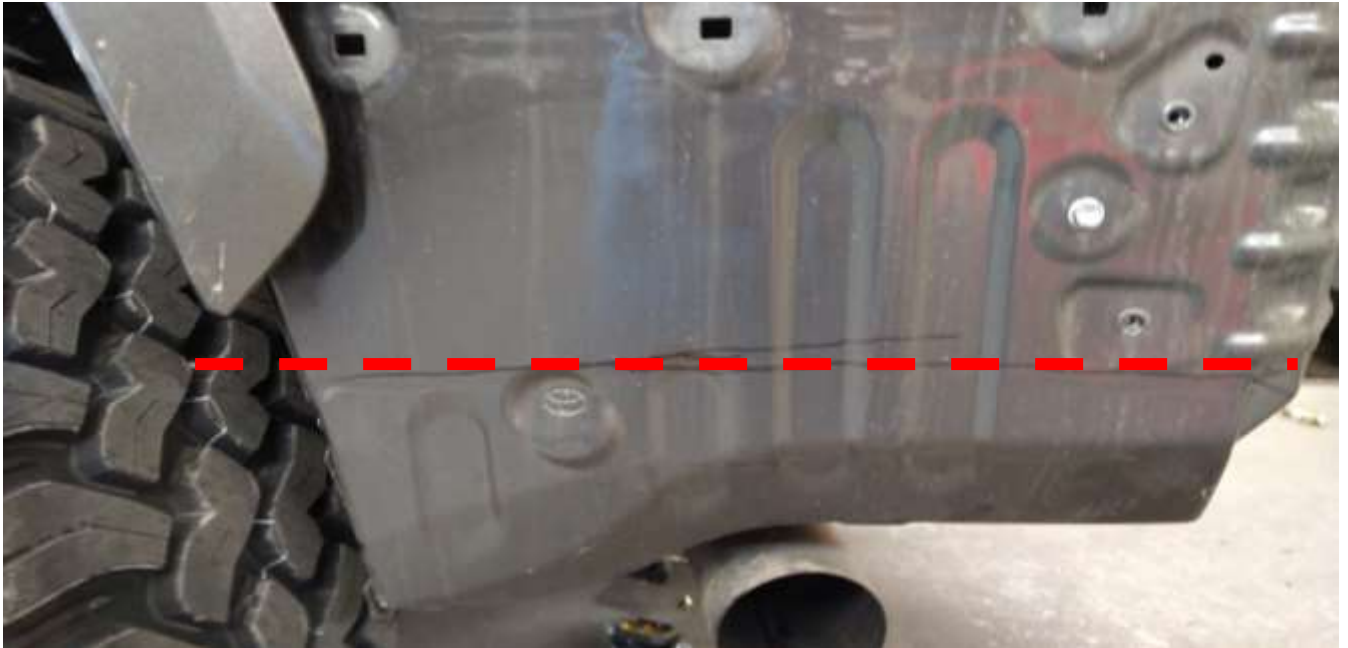

## 10 – FENDER MOUNTING

Secure the fender to the provided brackets and mount using the underside bed OEM and provided 5/16" hardware. Adjust as needed once the bumper has been installed.

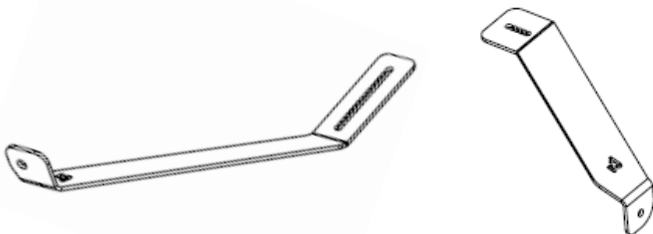

5/16" – 18 x 3/4" HEX CAP BOLT	4
5/16" – 18 NYLOC NUT	4
5/16" USS WASHER	8

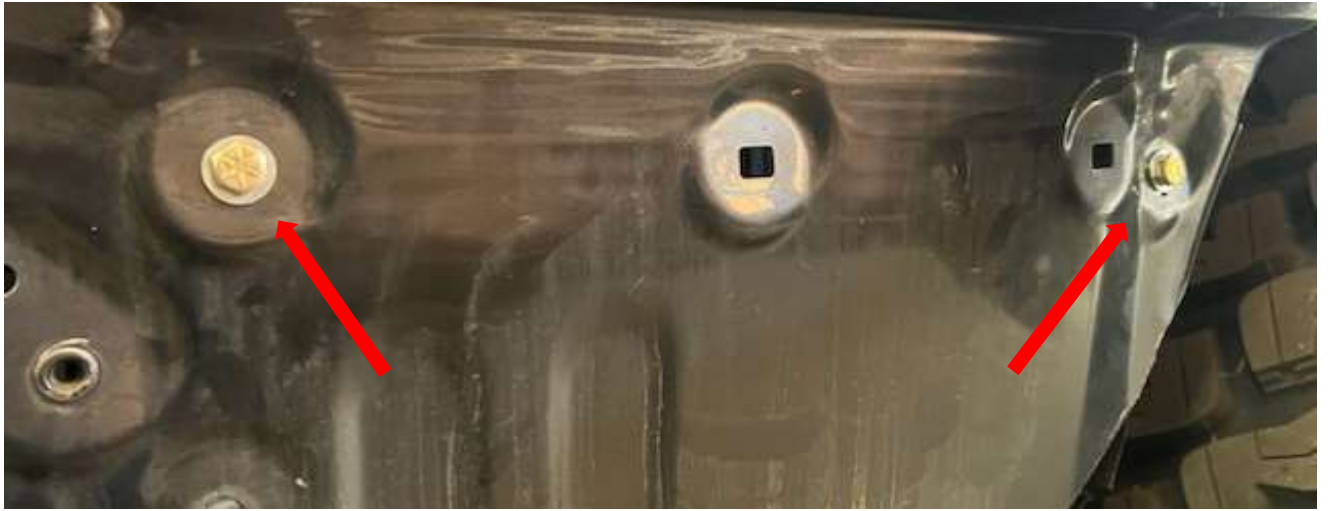

## 11 – EASE OF ACCESS

While mounting the fender brackets temporarily remove the OEM parts shown for access to the frame for bracket mounting in step 19. Replace once bumper is installed.



## 12 – BRACKET INSTALLATION

Mount the provided bracket to the frame using the OEM hardware and locations.



OEM HARDWARE

6

## 13 – SENSOR MOUNTING AND COVER

Mount the OEM sensors to the sensor plates using the provided 1/4" hardware. Insert the provided covers into the bumper and lock into place with the plate. Mount using the provided 1/4" hardware to the bumper.

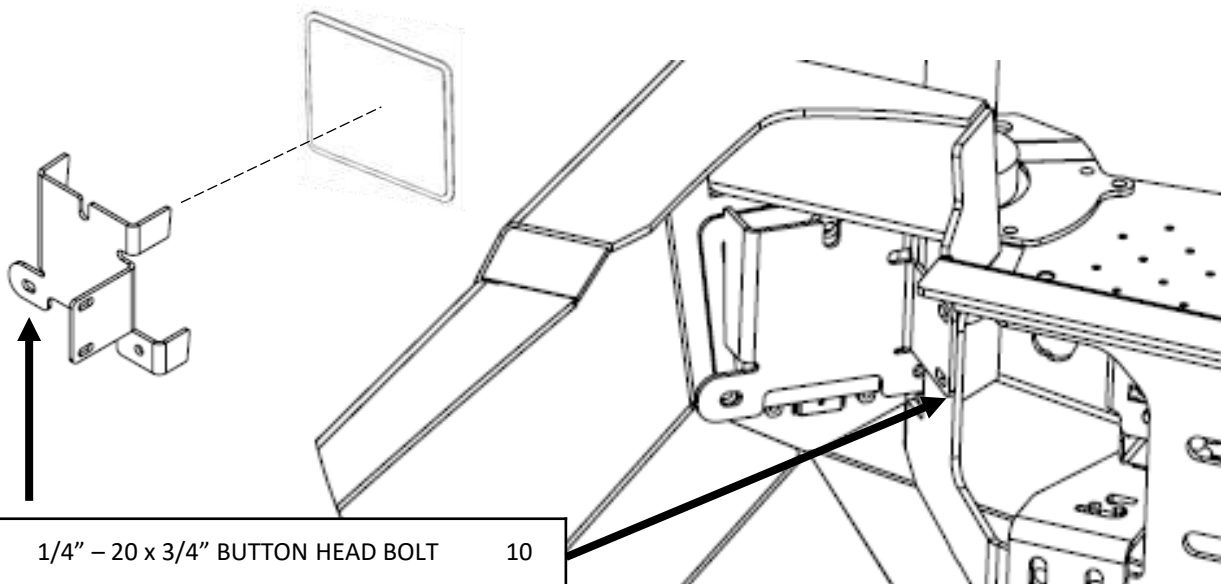

1/4" – 20 x 3/4" BUTTON HEAD BOLT	10
1/4" – 20 NYLOC NUT	10
1/4" SAE WASHER	10



## 14 – TREAD PLATE INSTALLATION

Install the tread plate and drop pin plates to both sides using the provided 1/4" hardware. Remove the plastic covering after installing the bumper.



## 15 – OEM LIGHTS

Install the OEM reverse/license plate lights with the provided brackets and 1/4" hardware. Install in the bumper using the provided 5/16" hardware.

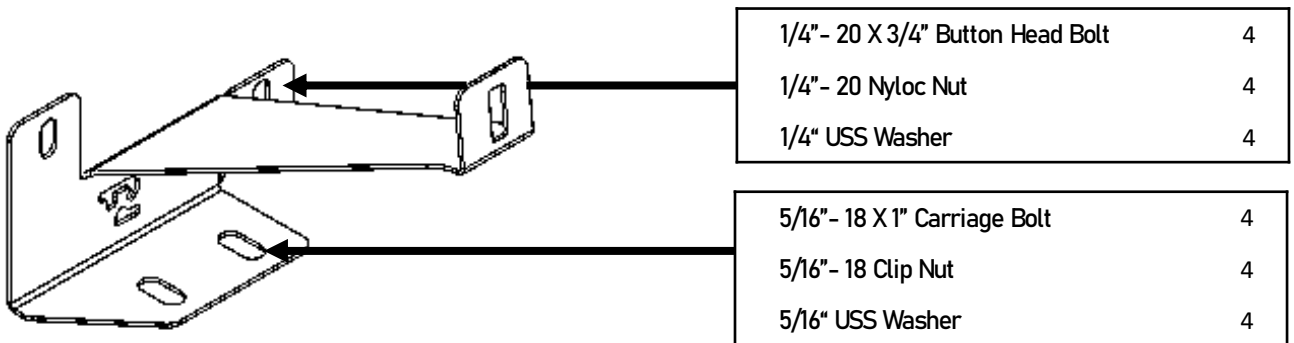

## 16 – LIGHT TABS

Mount the light tab to the light port area using the provided 3/8" hardware. See light ports guide for details.

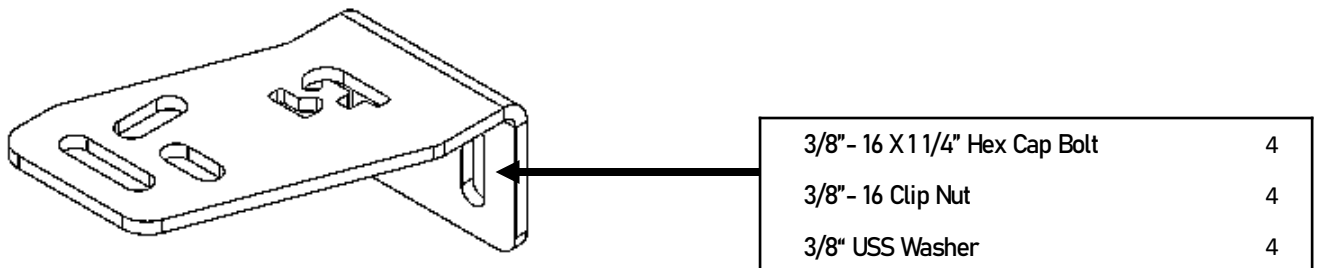

## 17 – WIRING HARNESS

Reconnect the wiring harness into the new bumper. Place all wiring out of the way of mounting points and hardware locations. Check that the wiring loom connectors match their original points of connection per each side of the vehicle and ACC sensor. Install the new bezels and connect the sensors. When using the provided replacement rubber bezels use WD40 and align the fat edge directional to the pointed surface when fitting. Secure the wiring loom.



## 18 – BUMPER MOUNTING

Mount the bumper as shown using the provided 1/2" hardware. Center the bumper with the vehicle and align gaps between the body and bumper to your preference before mounting.. Leave all hardware loose for adjustment.

1/2" – 13 x 1 1/4" HEX CAP BOLT	6
1/2" – 13 NYLOC NUT	6
1/2" USS WASHER	12

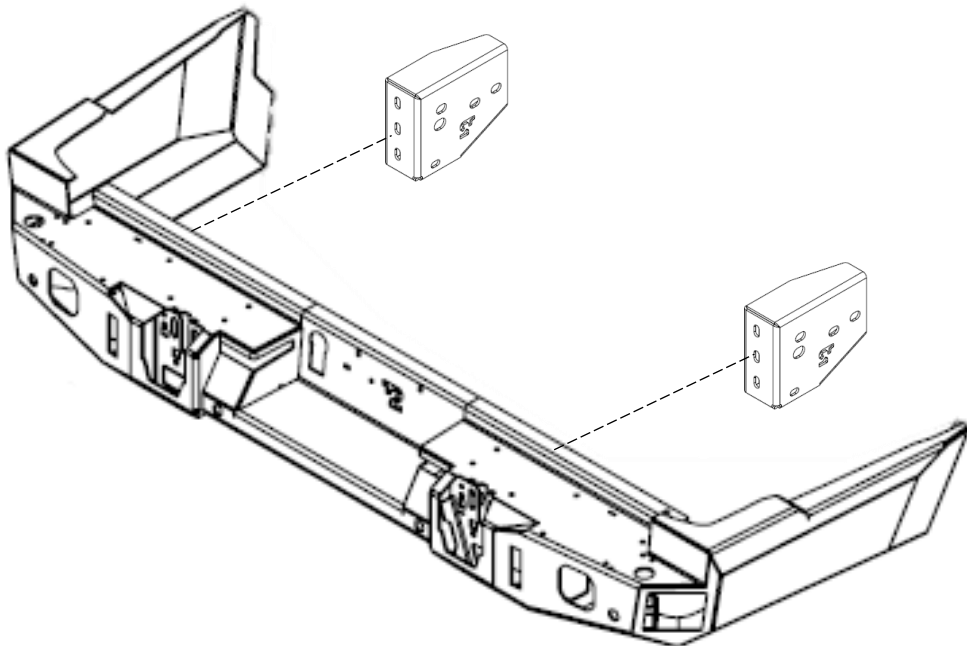
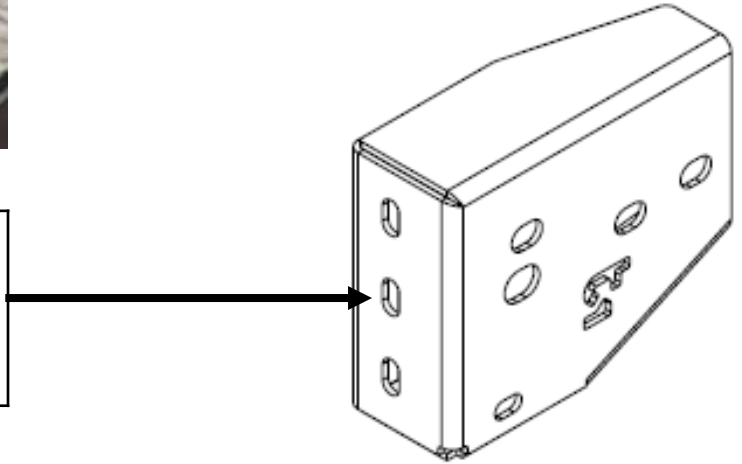

## 19 – CONTINUED

Pull the OEM plastic cap for both sides of the frame in the wheel well. First insert the single bolt retainer into the opening and place into location at the bottom bolt opening. Second in conjunction with step 11, insert the provided double nut retainer from the inside of the frame. Mount the side wing bracket once all nut retainers are in location.

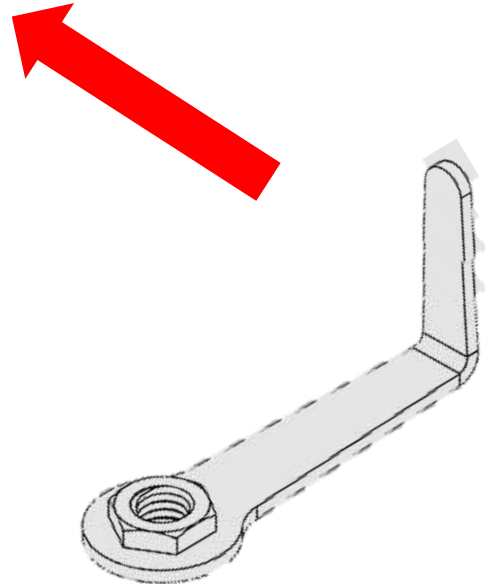

Use a socket extension as a handle to hold the nut retainer in place.



# 19 – CONTINUED

Mount the bracket as shown using the provided 3/8" and 1/2" hardware.

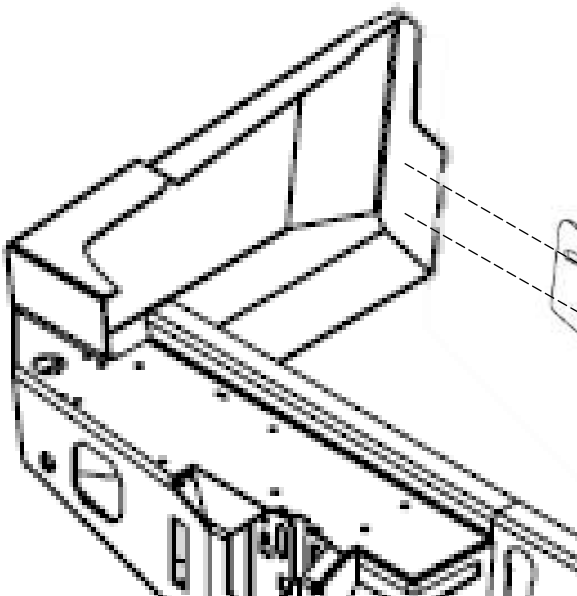
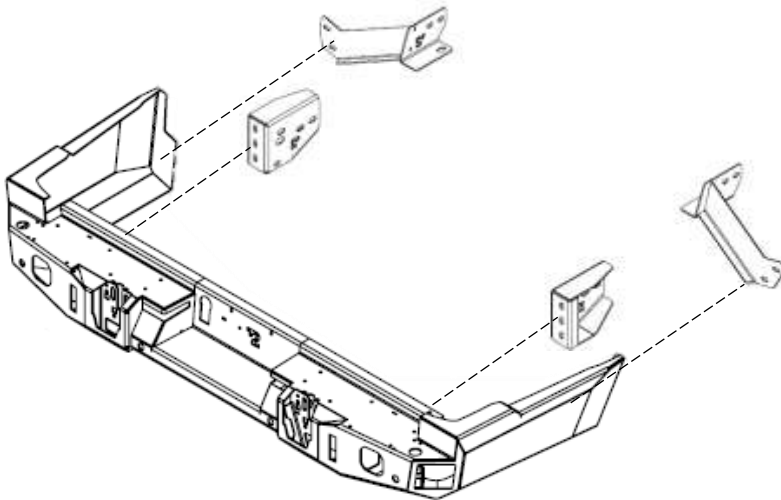
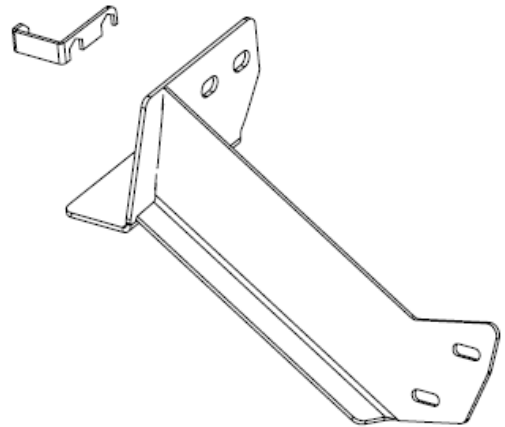

3/8" - 16 X 1" Button Head Bolt	4
3/8" - 16 Nyloc Nut	4
3/8" USS Washer	4

1/2" - 13 x 1 1/4" HEX CAP BOLT	6
1/2" USS WASHER	6

## 20 – TIGHTEN HARDWARE

Adjust the bumper to its desired location and TIGHTEN HARDWARE. Check that all hardware is tightened including all brackets and mounting locations. Reconnect the parking sensor wiring harness and other connections to the vehicles electronics and secure all loose wiring. Check that everything is working and adjust if needed before driving on the road.

### ADDITIONAL LINKS

<https://www.exp-one.com/wp-content/uploads/2016/10/Proper-Care-and-Maintenance.pdf>

<https://www.exp-one.com/wp-content/uploads/2016/10/Paint-touch-up-instructions.pdf>

<https://www.exp-one.com/wp-content/uploads/2018/02/Exp-One-2016-TC-word-doc.pdf>

**TIGHTEN ALL HARDWARE AFTER EVERYTHING IS INSTALLED ON THE VEHICLE  
CHECK AND RETIGHTEN ALL HARDWARE AFTER THE FIRST 100 MILES AND AFTER  
OFF ROADING. CHECK REGULARLY**